

KMD 150

Multifunction Display/GPS

Pilot's Guide



The information contained in this manual is for reference use only. If any information contained herein conflicts with similar information contained in the Airplane Flight Manual Supplement, the information in the Airplane Flight Manual Supplement shall take precedence.

WARNING

The enclosed technical data is eligible for export under License Designation NLR and is to be used solely by the individual/organization to whom it is addressed. Diversion contrary to U.S. law is prohibited.

COPYRIGHT NOTICE

Copyright © 2000-2002, 2004, 2005 Honeywell International Inc. All rights reserved.

Reproduction of this publication or any portion thereof by any means without the express written permission of Honeywell International Inc. is prohibited. For further information contact the Manager, Technical Publications; Honeywell Business & General Aviation; One Technology Center; 23500 West 105th Street; Olathe, Kansas 66061. Telephone: (913) 712-0400.

INTRODUCTION1

 DEFINITIONS, ACRONYMS AND ABBREVIATIONS 2

 Definitions 2

 Acronyms and Abbreviations. 4

GENERAL INFORMATION 9

 SOFT KEYING10

 SELECTABLE GPS DATA SOURCE10

 STORMSCOPE® OPTION11

 SOFTWARE ARCHITECTURE11

 SCREEN ICONS14

 OBSTACLE LABELS14

 TERRAIN AND URBAN AREAS DISPLAY14

 MEMORY LOCATIONS15

GETTING STARTED17

 INTRODUCTION17

 INITIALIZING YOUR UNIT17

 SOFTWARE STRUCTURE18

 SELECTING DEMO MODE19

 DATABASE SELECTION20

 A QUICK WORD ON DIRECT TOS AND FLIGHT PLANS20

 VISUAL DIRECT TO AND DATA INTERROGATION21

 DIRECT TO A SPECIFIC LATITUDE AND LONGITUDE21

 MANUAL DIRECT TO AND DATA INTERROGATION22

 EDITING/CREATING A USER WAYPOINT MANUALLY22

 EDITING/CREATING A USER WAYPOINT VISUALLY23

 SAVING A USER WAYPOINT IN FLIGHT23

 SELECTING STORMSCOPE MODE24

Table of Contents

EDITING/CREATING A FLIGHT PLAN MANUALLY24
EDITING/CREATING A FLIGHT PLAN VISUALLY25
SELECTING A FLIGHT PLAN TO FLY26
SELECTING A MAP MODE26
VIEWING ETAS, DIRECT-TO ON FLIGHT PLAN27
TEN NEAREST SEARCH27
SETUP MAP FUNCTIONS28
SETUP OF NAVIGATION FUNCTIONS30
CLEAR MEMORY31
TITLE AND HELP SCREENS33
SELF TEST AND INITIALIZATION34
MAIN MENU SCREEN35
NOTE PAD SCREEN35
GPS STATUS SCREENS37
ADJUSTING TIME AND DATE40
SETTING LOCAL TIME OFFSET40
SETTING PRESENT POSITION41
DATA INPUT (EXTERNAL GPS MODE)43
DISPLAY OF HOST FLIGHT PLAN DATA43
Bendix/King Data Format43
NMEA and Northstar data44
FLIGHT PLANNING SCREENS45
USER WAYPOINTS45
Basic User Waypoints45
Marker User Waypoints45
User Defined Airports46
VIEWING USER WAYPOINTS47

MANUAL USER WAYPOINT EDITING	48
GRAPHICAL USER WAYPOINT EDITING	49
EDITING USER AIRPORTS	50
FLIGHT PLANS	50
MANUAL FLIGHT PLAN BUILDING AND EDITING	51
MANUALLY INSERTING A WAYPOINT INTO A FLIGHT PLAN AND MANUAL DIRECT TO	53
Selecting Data Source	53
Selecting Item From Chosen Database	54
GRAPHICAL VIEWING AND EDITING OF FLIGHT PLANS	56
MAP MODE SCREENS	59
DATA INTERROGATION AND GRAPHICAL DIRECT TO	61
Airport Information	62
Navaid Information	62
General Icon Information	63
Airspace Interrogation	63
NAV MENU SCREENS	65
SELECTING A FLIGHT PLAN	67
TEN NEAREST AIRPORTS	68
NAVAIDS	70
MAP MODE WITH NAV INFORMATION	73
VIEWING ENROUTE ETA'S, PERFORMING A DIRECT-TO ON TOP OF FLIGHT PLAN	75
Performing A Direct-To On Top of A Flight Plan	75
Performing a DIRECT TO a point not in the active Flight Plan.	75
ARRIVAL AT AN ENROUTE WAYPOINT	76
ARRIVAL AT YOUR FINAL DESTINATION	77

Table of Contents

ALTERNATIVE MAP MODES	78
Large Text Mode	78
CDI Mode	78
E6-B CALCULATOR	81
DENSITY ALTITUDE/TAS/WINDS ALOFT CALCULATOR	81
To Calculate Density Altitude (DALT) and True Airspeed (TAS) . . .	81
To Calculate Winds Aloft (WIND) and Headwind/Tailwind Component (COMP)	82
VERTICAL NAVIGATION (VNAV)	82
TRIP/FUEL PLANNING	84
SUNSET/SUNRISE CALCULATOR	86
SETUP SCREENS	87
MAP SETUP SCREENS	87
Settings Available	88
NAV MODE SETUP	92
PERSONAL IDENTIFICATION NUMBER (PIN) SETUP	94
Auto Power-On Lock	96
INSTALLATION AND DIAGNOSTIC SCREENS	97
Screen Position Setup	97
View Logs	98
Engineering Log	98
GPS Receiver Information Log	98
Clear Memory	99
Data In/Out	100
External GPS Data Input Option	101
Output Test	102

STORMSCOPE® OPERATION	105
INTRODUCTION	105
FUNCTIONAL DESCRIPTION	105
Cell Display Mode	106
Strike Display Mode	106
STORMSCOPE® MODE FEATURES	106
ANATOMY OF A THUNDERSTORM	107
Stages of a Thunderstorm	108
Cumulus Stage	108
Mature Stage	109
Dissipating Stage	109
THE WX-500 AND WEATHER RADAR	109
OPERATION	110
Power-up	110
Continuous and Operator-initiated Self Test	110
Heading Stabilization	110
Clear all Discharge Points	111
Switch Between Weather Views	111
Switch Between WX Display Modes	111
Changing Display Range	111
Operation in Stormscope® Mode with Nav Overlay	112
Operation in Map Mode	112
Error Messages	113
Non-Fatal Faults	114
Recoverable Faults	114
Heading Related Faults	114
Non-Recoverable Faults	114
Fatal Faults	114

Table of Contents

WEATHER DISPLAY INTERPRETATION	115
Introduction	115
Radial Spread	116
Typical Patterns	116
Three Clusters Within the 200nm Range Ring	116
Two Clusters Within the 200nm Range Ring	119
Mapping Headings Past Thunderstorms	120
Range Set at 200nm	120
Aircraft Progresses 100nm	121
Range Changes to 100nm	122
Aircraft Turns to Avoid Thunderstorms	123
Special Patterns	124
Randomly Scattered Discharge Points	124
Cluster and Splattering Within 25nm	125
Discharge Points Off Aircraft's Nose	126
Line of Discharge Points While Taxiing	127
Developing Cluster Within the 25nm Range Ring	128
DEMO MODE	129
STORMSCOPE® DEMO MODE	130
APPENDIX 1 - WARNING SCREENS	131
RAM LOST WARNING	131
MEMORY BATTERY WARNING	131
PIN LOCK WARNING	132
LOCK OUT WARNING	132
NEW DATABASE CARD WARNING	133

APPENDIX 2 - DATABASE CARDS135

 DATA AREAS135

 CHANGING THE DATABASE CARD136

 MINIMUM SAFE ALTITUDES (MSA)136

 Flight Plan Building136

 During Flight137

 WORLD-WIDE ICAO CODES137

APPENDIX 3 - HOW DOES GPS WORK?147

 WHAT IS GPS?147

 HOW DOES GPS WORK?147

 ACCURACY AND RELIABILITY149

APPENDIX 4 - DIFFERENTIAL FUNCTIONS151

 WHAT IS DGPS?151

 HOW DOES DGPS WORK?151

 USE OF DGPS152

APPENDIX 5 - DATABASE INFORMATION153

 DATABASE CYCLE INFORMATION153

Intentionally left blank

SCREEN INDEX

Screen 1: Title Screen	.33
Screen 2: Main Menu Screen	.35
Screen 3: GPS Status Screen	.37
Screen 4: Date and Time Adjustment Screen	.40
Screen 5: Local Time Offset Screen	.40
Screen 6: Present Position Setup Screen	.41
Screen 7: Flight Planning Mode Cover Screen	.47
Screen 8: User Waypoint Viewer Screen	.47
Screen 8A: User Airfield Edit Screen	.50
Screen 9: Manual User Waypoint Edit Screen	.48
Screen 10: View and Edit User Waypoints on the Map Screen	.49
Screen 10A: View Map Screen	.41
Screen 11: Flight Plan Selection Screen	.50
Screen 12: Flight Plan Program/Edit Screen	.51, 68
Screen 13: Database Selection Screen	.53
Screen 15: Temporary Waypoint Input Screen	.54
Screen 16: Item Selection Screen	.54
Screen 19: View and Edit Flight Plans On Map Screen	.56
Screen 20: Demo Mode Setup Screen	.129
Screen 21: Setup Cover Screen	.87
Screen 22 : Map Customization Screen	.87
Screen 22A: Point Features Data Class Setup Screen	.90
Screen 22B: Line Features Data Class Setup Screen.	.91
Screen 22C: Airspace Data Class Setup Screen	.91
Screen 23: NAV Mode Customization Screen	.92
Screen 24: PIN Setup Cover Screen	.94

Table of Contents

Screen 25: PIN Incorrect Screen94
Screen 26: PIN Change & Power-On Lock Enable Screen95
Screen 27: PIN Change Screen95
Screen 28: Installation and Diagnostics Cover Screen97
Screen 30: Engineering Log Screen98
Screen 31: GPS Receiver Information Screen (Internal GPS Units Only)	98
Screen 32: Memory Clear Entry Screen99
Screen 33: Memory Clear Cover Screen99
Screen 35: Data Input/Output Setup and Test Screen100
Screen 35B: GPS Source Change Warning Screen101
Screen 37: Aviation Interface Output Test Screen102
Screen 38: Basic Map Mode Screen59
Screen 39: Map Mode with Joystick Active Screen61
Screen 40: Map Mode Airport Info Screen62
Screen 40A: Map Mode Navaid Information Screen62
Screen 40B: Airspace Information Screen64
Screen 40C: Map Mode General Information Screen63
Screen 41: NAV Menu Cover Screen65
Screen 41A: View ETA's and Direct-To Screen.75
Screen 42: Flight Plan Selection Screen67
Screen 43: Ten Nearest Airfields Screen68
Screen 44: Airport Information Screen69
Screen 45: Ten Nearest Navaids Screen70
Screen 46: Navaid Information Screen70
Screen 47: Map Mode with NAV Information Screen73
Screen 47A: Large Text & Map NAV Information Screen.78
Screen 47B: Large Text & CDI (Pseudo HSI) NAV Information Screen . .	.78

Screen 48: NAV Information and WTP IMMEDIATE Flags Showing -
Enroute Screen76

Screen 49: NAV Information and TP IMMEDIATE Flags Showing -
Final Screen77

Screen 50: Representation of Screen 47 Showing DEMO MODE Flag . .130

Screen 51: RAM Lost Warning Screen131

Screen 52: Memory Battery Warning Screen131

Screen 54: Power On Security PIN Entry Screen132

Screen 55: Lockout Screen132

Screen 56: Flight Plan Change Warning Screen133

Screen 57: E6-B Calculator Cover Screen 81

Screen 58: Density Altitude, True Air Speed & Winds Aloft Screen 81

Screen 59: VNAV Setup Screen 83

Screen 60: Trip / Fuel Flight Plan Select Screen 85

Screen 61: Sunset/Sunrise Calculator Screen 86

Screen 62: Notepad Screen 35

Intentionally left blank

INTRODUCTION

All of us at Honeywell congratulate you on choosing this product. You are now the owner of one of the most sophisticated yet simple-to-use Nav aids available today. We understand you probably can't wait to see it in action but before you try to use it do please take the time to read through this manual and understand its many interesting and useful features. Time spent in familiarizing yourself with your new KMD 150 unit will be more than repaid by trouble-free operation later, and more importantly safe and accurate navigation.

We have made the operation of this unit as intuitive as possible through the use of soft keying and on-screen help, thus reducing pilots' dependence on the manual. You should very quickly find that handling it efficiently and expertly becomes second nature to you. Don't be afraid to experiment. No matter which key you activate, your unit will not be damaged. If you do get into a mess, simply switch off and back on again to reset all functions. We must mention just one word of caution. **Never remove the database card while the unit is switched on and never attempt to switch the unit on when there is no database card installed.**

We thank you for your decision to purchase a KMD 150 and wish you many happy and safe hours flying.

WARNING

The Global Positioning System (GPS) satellite constellation is operated by the Department of Defense (DOD) of the United States, which is solely responsible for its accuracy and maintenance. Although declared fully operational on July 17, 1995, the system is still under development and subject to changes that could affect the accuracy and performance of all GPS equipment.

Use this equipment at your own risk. Your new KMD 150 unit is a precision navigation aid but like any nav aid it can be misused or misinterpreted and so become unsafe. You are strongly advised to read and fully understand this manual before using the equipment. If your unit has an internal GPS then a DEMO MODE or simulation facility exists that allows you to practice with it before you begin using it for actual navigation.

Whenever you are using the unit for navigation in the air you should treat it as a supplemental navigation system. You should always carefully compare indications from your KMD 150 unit with the information available from all other navigation sources including NDBs, VORs, DMEs, visual sightings, charts, etc. For safety, any discrepancies observed should be resolved immediately.

Introduction

The altitude calculated by GPS equipment is geometric height above a theoretical mean sea level of a mathematically calculated ellipsoid that approximates to the shape of the earth. This altitude can differ significantly from that displayed by your pressure altimeter. You must therefore, **NEVER USE GPS ALTITUDE FOR VERTICAL NAVIGATION OR TERRAIN AVOIDANCE.**

This equipment is not a replacement for your chart. It is intended as an aid to navigation only. The database within the equipment has been compiled from the latest official information available, and although every care has been taken in the compilation, the manufacturers will not be held responsible for any inaccuracy or omissions therein. **NEVER USE THE TERRAIN DISPLAYED ON THIS EQUIPMENT AS YOUR SOLE REFERENCE FOR TERRAIN AVOIDANCE.**

DEFINITIONS, ACRONYMS AND ABBREVIATIONS

DEFINITIONS

Alphabetic: any of the following characters (b/ is a space): b/ABCDEFGHIJKLMN**OP**QRSTUVWXYZ

Alphanumeric: any of the following characters (b/ is a space): b/ABCDEFGHIJKLMN**OP**QRSTUVWXYZ0123456789

Baud: bits per sec

Barometric Altitude: pressure altitude corrected for barometric altimeter setting

Bearing To Waypoint: bearing from the present position to the active waypoint measured clockwise relative to true or magnetic north (true is implied unless magnetic is specified)

Cross Track Error: distance from the present position to the nearest point on the desired course, and the direction (right or left) from the desired course to the present position

Cursor Field: a character position or group of adjacent character positions on which a cursor can appear

Data Entry Field: A data entry field is an enterable data field where the ENTER, SET or SELECT button must be pressed before data entered in the field becomes effective. A data entry field can be a single or multiple character cursor field. During data entry, the active cursor field remains reverse video.

Data Field: a character position or group of adjacent character positions which display a single data item; a data field may be a single character cursor field, or may contain multiple characters.

Data List: an ordered list of data elements which a given cursor field can accept

Desired Track: The angle that the desired flight path makes with respect to true north at the point nearest the present position. Magnetic desired track uses the local magnetic variation.

Destination: If the active waypoint is not in the active flight plan, the active waypoint is the destination. If the active waypoint is in the active flight plan, the final waypoint in the flight plan is the destination.

Distance To Waypoint (DIS): distance from the present position to the active waypoint

Enroute Safe Altitude: the highest minimum safe altitude which will be encountered for a given flight path (present position to destination, via flight plan if appropriate; or a flight path being analyzed by trip planning)

Ground Speed: absolute value of the rate of change of position

Headwind: difference between true airspeed and ground speed when true airspeed is more than ground speed

Knots: Nautical Miles/hr

Minimum Safe Altitude: Minimum safe altitude is the highest minimum off route altitude for any sector within a 10 nm square centered at a given position. A minimum off route altitude of 7000 feet or less clears all known obstructions and terrain in a sector by 1000 feet; a minimum off route altitude greater than 7000 feet clears all terrain by 2000 feet. A sector is an area bounded by a 1° latitude/longitude grid.

Scrolling Region: a set of consecutive cursor fields which display a portion of a scroll list; “scroll up” means that the data item in each cursor field in the scrolling region moves to the preceding cursor field. The data item in the first cursor field disappears from the page, and the last cursor field displays the next item in the scroll list; “scroll down” is the opposite. If there is other data associated with the data in the cursor fields (such as user waypoint numbers in flight plans), it also moves.

Selected Course: The angle that the desired flight path makes with respect to true north at the active waypoint. Magnetic selected course uses the magnetic variation at the active waypoint; if the active waypoint is a VOR, the magnetic variation stored for that VOR is used.

Special Use Airspace: any of the following: prohibited area, restricted area, warning area, alert area, MOA, Class CARSA, Class BTCA, unknown, danger, caution, training, CTA, or TMA type.

Standard Rate Turn: 3°/sec

Tailwind: difference between ground speed and true airspeed when ground speed is more than true airspeed

Introduction

Terminal Waypoints: waypoints that are duplicated within a country code or “unnamed” waypoints associated with an approach that are assigned to distinct airports

Time To Waypoint: distance to waypoint divided by ground speed

Track: angle of the aircraft’s path over the ground measured clockwise relative to true or magnetic north (true is implied unless magnetic is specified).

ACRONYMS AND ABBREVIATIONS

- AC:** Alternating Current
- ACT:** Active (waypoint or flight plan)
- ADF:** Automatic Direction Finder
- AGL:** Above Ground Level
- ANSI:** American National Standards Institute
- APT:** Airport
- ARTCC:** Air Route Traffic Control Center
- ASCII:** American Standard Code for Information Interchange
- ATC:** Air Traffic Control
- ATF:** Aerodrome Traffic Frequency
- ATIS:** Automatic Terminal Information Service
- A/C:** Aircraft
- baud:** or Baud Rate; a measurement of data transmission speed
- BRG:** Bearing
- CAA:** Civil Aviation Authority
- CAS:** Calibrated Airspeed
- com:** communication
- CDI:** Course Deviation Indicator
- CTA:** Control Area
- CTAF:** Common Traffic Advisory Frequency
- CTR:** Control Zone

CTZ:	Control Tower Zone
CWI:	Continuous Wave Interference
dB:	decibels
DC:	Direct Current
DIS:	Distance
DME:	Distance Measuring Equipment
DOT:	United States Department of Transportation
EFIS:	Electronic Flight Instrument System
ELT:	Emergency Locator Transmitter
ESA:	Enroute Safe Altitude
ETE:	Estimated Time Enroute
FAA:	Federal Aviation Administration
FAR:	Federal Aviation Regulations
FPL:	Flight Plan
FPM:	Feet Per Minute
FSS:	Flight Service Station
ft:	feet
FT:	Feet
G:	Gravitational Acceleration = $32.2 \text{ ft/sec}^2 = 19.3 \text{ kt/sec}^2$
GAL:	Gallons
GPS:	Global Positioning System
hr:	hour
HSI:	Horizontal Situation Indicator
Hz:	Hertz
IAF:	Initial Approach Fix
IAP:	Instrument Approach Procedure
IEEE:	Institute of Electrical and Electronics Engineers
IFR:	Instrument Flight Rules
in.:	inches

Introduction

INT:	Intersection
kHz:	kilohertz
Kt.:	Knots
KΩ:	Kilohms
LAT:	Latitude
LB:	Pounds
LED:	Light Emitting Diode
LON:	Longitude
LONG:	Longitude
LRU:	Line Replaceable Unit
m:	meters
mA:	milliamperes
MATZ:	Military Air Traffic Zone
MAHP:	Missed Approach Holding Point
MAP:	Missed Approach Point
mB:	millibars
MF:	Mandatory Frequency
MHz:	Megahertz
mi:	statute miles
min:	minutes
MOA:	Military Operation Area
MSA:	Minimum Safe Altitude
MSL:	Mean Sea Level
msec:	milliseconds
NDB:	Non-Directional Beacon
nm:	Nautical Miles
NPA:	Non Precision Approach
NVM:	Non Volatile Memory
OBI:	Omni-directional Bearing Indicator
OBS:	Omni-directional Bearing Selector

PETE:	Pointer ETE
PIN:	Personal Identification Number
RAD:	Radial
REF:	Reference
RMI:	Radio Magnetic Indicator
RTCA:	Radio Technical Commission for Aeronautics
SA:	Selective Availability (intentional errors introduced by the DOD)
SAT:	Static Air Temperature
sec:	seconds
SID:	Standard Instrument Departure
SNR:	Signal to Noise Ratio
STAR:	Standard Terminal Arrival Route
SUP:	Supplemental Waypoint
TAS:	True Airspeed
TAT:	Total Air Temperature
TD:	Time Difference
TMA:	Terminal Control Area
TOPO:	Topographical Data (i.e. coastlines, terrain, rivers, lakes etc)
TSO:	Technical Standard Order
UTC:	Universal Coordinated Time (same as Greenwich Mean Time)
V:	Volts
VHF:	Very High Frequency
VNV:	Vertical Navigation
VOR:	Very High Frequency Omni-directional Radio Range
VRP:	Visual Reference Point
W:	Watts
wpt:	Waypoint
μsec:	microsecond

Introduction

μV:	microvolts
Ω:	Ohms
°C:	degrees Celsius
°F:	degrees Fahrenheit

GENERAL INFORMATION

This section of the manual explains how it should be used and provides you with an overview of the software architecture and screen presentation of your KMD 150 Multifunction Display/GPS.

This manual provides a detailed explanation of each of the individual screens that your KMD 150 unit displays, and will take you step by step through each of them. To simplify this process each Screen is numbered and indexed at the front of this manual for reference. For those users who wish to get stuck into operating the system immediately, the Quick Reference Section of the manual has been designed to get you up and running.

The operating system of the Bendix/King KMD 150 keeps to a minimum the number of key presses necessary to activate the various functions, especially those most frequently used in the air. The provision of a joystick makes it considerably simpler to operate the unit and allows you fast and efficient access to most functions.

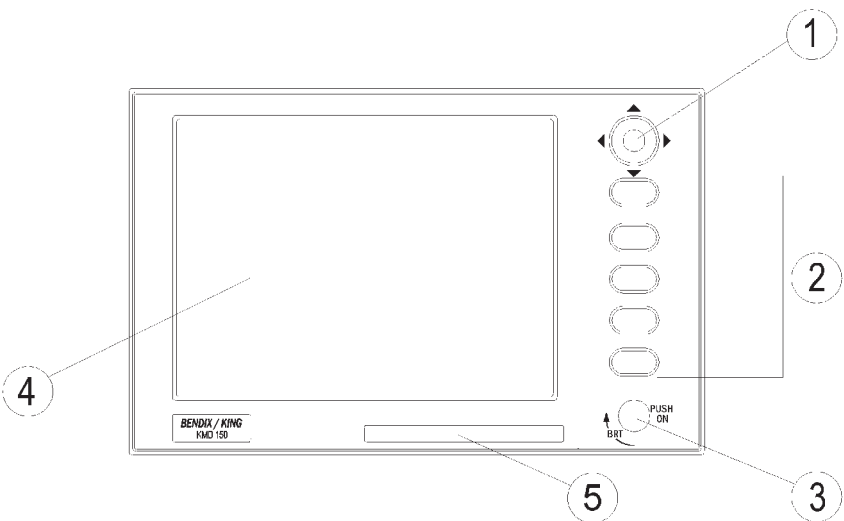

1. Joystick
2. Function Keys
3. ON/OFF/Brightness Control
4. Full Color TFT Liquid Crystal Display
5. Database Card

SOFT KEYING

You will notice that a label is drawn alongside each valid key. Whenever a new function is selected, by pressing a valid key, a new screen is displayed along with its new key labels. This capability of drawing key labels that are only applicable to a particular screen is referred to as 'soft keying', and allows one key to perform multiple functions without the complications of multiple key presses on a conventional keypad.

For the purpose of describing the function of a particular key in this manual, assume that all the keys on the pictured screen drawings are numbered 1 - 5 from top to bottom. The ensuing text will use this numbering sequence to refer to each specific key. The number shown alongside the pictured screen drawings refers to the number of the screen that is called when that key is pressed. By using these numbers it is possible to follow the paths through the operating system for all functions. If the word RET is printed next to a key, this means that after the key function is performed the same screen is RETurned. A good example of this is ZOOM IN. If the word RTS is printed next to a key, this means that after the key function is performed the previous screen is then displayed. All screen drawings show the KMD 150 running from it's internal GPS receiver. Variations affecting the KMD 150 when connected to an external GPS are described in the accompanying text.

SELECTABLE GPS DATA SOURCE

The KMD 150 is available with or without an internal GPS receiver. The internal GPS version of KMD 150 has a built in eight channel parallel GPS (Mod 5 and above have 12 channel GPS) receiver but like the non-GPS version, can also accept data from an external source such as a Bendix/King KLN 89B if necessary. When set to internal GPS source, all waypoint and flight plan programming is carried out and executed on the KMD 150. When using the internal GPS receiver, the KMD 150 can also drive your autopilot and panel mounted indicators and annunciators.

If you have the non-GPS version of KMD 150 or if an external GPS source is selected for use with the full GPS version, all internal navigation options are inhibited on the KMD 150 and instead, the active flight plan and waypoints are imported directly from the host GPS. When using external GPS data, the KMD 150's autopilot and annunciator outputs are disabled.

The navigation data source is always annunciated in Map Mode by a small label located in the upper left of the screen. This label will show INT NAV when using the internal GPS receiver and EXT NAV when using an external GPS or LORAN receiver.

STORMSCOPE™ OPTION

The KMD 150 has the ability to interface and control a L-3 Communications WX-500 Stormscope® 'black box' thunderstorm sensor. The Stormscope® interface is switched on and off by using the joystick while displaying the Main Menu screen. When the Stormscope® interface is selected on, Key 1 on the main menu screen gives access to a dedicated Stormscope® screen. If selected in the Map Setup menus, lightning icons will also appear on the map screens along with a visual and aural warning that there are thunderstorms in your vicinity.

SOFTWARE ARCHITECTURE

The software in your KMD 150 unit is tree structured. An analogy can therefore be drawn between the trunk of a tree and MAIN MENU. MAIN MENU is the heart of the operating structure and can be accessed by pressing the HELP key after switching on the unit or pressing the MAIN MENU key at any other time.

Software Architecture

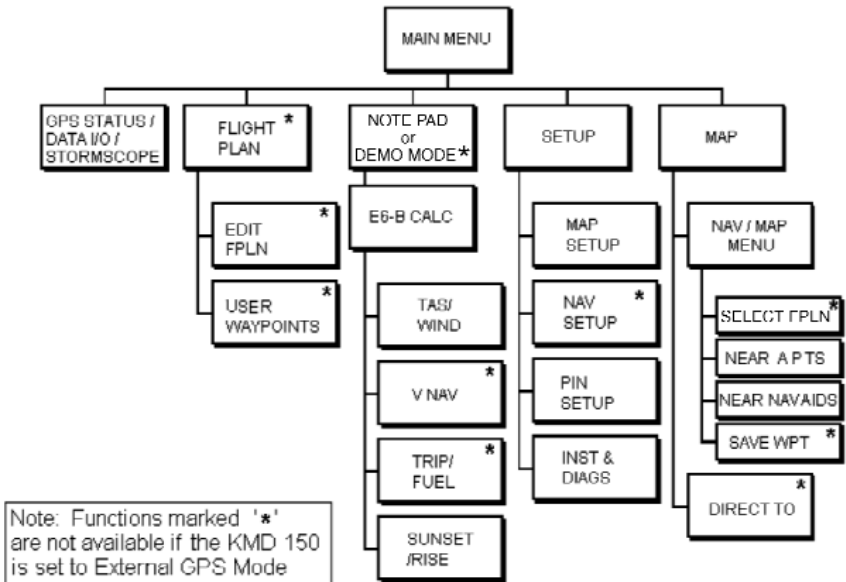

MAIN MENU has 5 main software branches, which in turn have their own sub software branches. The diagram above depicts the complete tree structure and will serve as a good point of reference while you are familiarizing yourself with your unit.

General Information

GPS STATUS If using the internal GPS, this shows satellite signal strength, allows UTC, local offset, date and position to be set, which will speed up the initialization of your unit.

DATA I/O If using an external GPS, this shows the data input/output settings and status.

STORMSCOPE® If a WX-500 Stormscope® is interfaced; this shows a Stormscope® style display of the local thunderstorm activity.

FLIGHT PLAN Allows user defined user waypoints and flight plans to be edited/created.

EDIT FPLN Allows user defined flight plans to be edited /created either manually or visually.

USER WPTS Allows user defined user waypoints, airports and marker functions to be edited/created either manually or visually.

DEMO MODE Allows you to practice operating the unit on the ground using a built in simulator. This is available only on units with an internal GPS active.

NOTE PAD Allows up to 4000 characters of text, previously downloaded from a PC using Flight Manager(tm) software to be viewed. This key in only available if DEMO MODE is not running. DEMO MODE can only be selected from the first screen when switching on the unit.

E6-B CALC Allows the E6-B Calculator to be used.

TAS/WIND Allows density altitude, TAS and winds aloft to be calculated.

NAV Allows vertical navigation to be Setup.

TRIP/FUEL Allows fuel and trip information to be calculated.

SUNSET/RISE Allows sunset and sunrise times to be calculated.

SETUP Allows Setup of map, navigation and input/output characteristics.

MAP SETUP Allows all map functions to be customized, including map tracking, airport names, map units, map datum, language, minimum runway length/surface, extended track, auto zoom, map decluttering, logging rate, position reporting references and airspace alerting.

NAV SETUP Allows all the NAV functions to be customized, including CDI scale, CDI display, CDI alarm, arrival alarm, auto next leg/leg selection philosophy, turn anticipation and flightplan display.

- PIN SETUP** Allows the PIN security function to be Setup.
- INST & DIAGS** Allows installation and diagnostics for data input/output and GPS receiver (if fitted) to be performed. Flight logs can be viewed and various sections of memory can be cleared from here.
- MAP** This is the primary operating mode of the unit.
- NAV MENU** Accesses all navigation functions and MSA information. Joystick toggles NAV Mode (only available if using internal GPS).
- FLIGHT PLAN** Allows a Flight Plan to be selected and edited.
- NEAR APTS** Allows emergency search of 10 nearest airports, providing information and DIRECT TO capability. Includes Jeppesen and user defined airports which satisfies the minimum runway length and surface requirements.
- NEAR NAVAID** Allows emergency search of 10 nearest navaids (VORs and NDBs), providing information and DIRECT TO capability.
- SAVE WPT** Allows your present co-ordinates to be saved in the next available user waypoint number.
- MAP MENU** Accesses all navigation functions and MSA information. Joystick toggles MAP mode (only available if using external GPS).
- NEAR APTS** Allows emergency search of 10 nearest airports, providing bearing and distance information. Includes Jeppesen and user defined airports which satisfies the minimum runway length and surface requirements.
- NEAR NAVAID** Allows emergency search of 10 nearest navaids (VORs and NDBs), providing bearing and distance information.
- NEAR INTS** Allows search of 10 nearest intersections, providing bearing and distance information.

General Information

DIRECT TO Allows the user to perform a DIRECT TO any point in the internal or user defined database. It may also be used to obtain information on any point in the database.

There are short cuts that allow you to get to the primary operating mode, MAP mode, more easily; but in general if you wish to get to a specific function in another branch of software, work your way back up the present branch to MAIN MENU by pressing either the PREV PAGE or MAIN MENU keys. Then select the branch of software that contains the desired function you wish to access.

SCREEN ICONS

KMD 150 Screen Icon Options

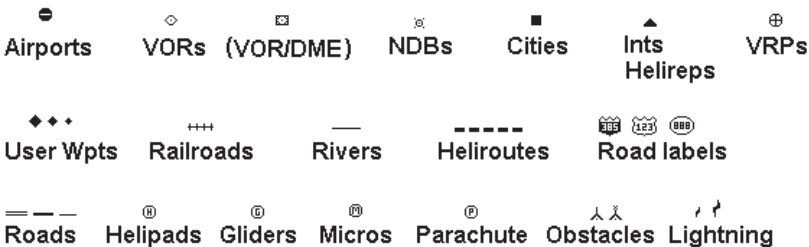

When showing any map screen - airports, nav aids, towns, intersections, user waypoints and many other data classes are represented by symbols or icons, some of which are user selectable in the Map Setup Screens. Please refer to the Setup Screens Section of this manual for further details.

OBSTACLE LABELS

Obstacles (available in the AMR cartridge for the United States and some other regions) are labeled with two numbers. The first number is the height of the obstacle in FEET ABOVE MSL. The second number (in brackets) is the height of the top of the obstacle in FEET AGL. Obstacle data for many countries is included in your KMD 150. However, you should never rely on your KMD 150 as your sole source for obstacle information, and you should always check the relevant AIP and NOTAMs.

TERRAIN AND URBAN AREAS DISPLAY

On all map screens, the land is shaded to show rising ground in seven elevation levels similar to those seen on a paper chart. In addition, all

built up or urban areas are shaded light gray. The levels and colors for the terrain shading are:

TERRAIN

<u>Color</u>	<u>ATI Level</u>	<u>AMR & PAI Level</u>
Light Green	Less Than 500 feet	Less Than 1000 feet
Medium Green	501-1000 feet	1001-2000 feet
Dark Green	1001-2000feet	2001-3000 feet
Light Brown	2001-3000 feet	3001-5000 feet
Medium Brown	3001-5000 feet	5001-9000 feet
Dark Brown	5001-9000 feet	9001-13000 feet
White	Greater Than 9001 feet	Greater Than 13001 feet

A color key is displayed on the Nav Menu (or Map Menu if in External GPS Mode). This is just one key press away from the main Map screen so you can refer to it easily during flight.

By default, terrain data is displayed at all zoom levels. The display of terrain data can however be switched on and off at different zoom levels if desired. See the section covering the Map Setup screen for more details.

WARNING

The colored terrain elevation shown on the KMD 150 is only intended to aid visual navigation by providing a depiction of the terrain that may be visible. It is not intended for terrain avoidance. NEVER USE THE TERRAIN DISPLAYED ON THIS EQUIPMENT AS YOUR SOLE REFERENCE FOR TERRAIN AVOIDANCE.

MEMORY LOCATIONS

In the function descriptions, three types of memory, RAM, NVM and Memory Card are mentioned. You may find it useful to know where various types of information are stored in order to make best use of the equipment. The RAM (Random Access Memory) is built into the unit and is used to store all user-defined data such as waypoints and flight plans. The RAM is maintained by battery power from an internal Lithium cell, which should be replaced by your Honeywell dealer every three years to prevent loss of user-defined data. The NVM (Non Volatile Memory) is also built into the unit. It stores initialization data, serial number, PIN number and performance log details. This memory is non-volatile, which means it is retained even if the memory battery is removed. If you choose to activate the PIN number security feature (similar to that available on many car radios) the non-volatile nature of the NVM ensures your PIN can not be tampered with or erased.

General Information

The Memory Card is used to hold the operating system and the database. The Memory Card can be replaced periodically in order to upgrade the operating system and update the database.

GETTING STARTED

This section of the manual is designed to provide you with a quick reference guide into the operation of your Bendix/King KMD 150 unit; taking you step by step through the most common functions. If more detail is required, please refer to the appropriate sections in this manual. Where the KMD 150 is connected to an external GPS source, operation may differ slightly. These differences are explained in italic text after each paragraph.

INTRODUCTION

Your KMD 150 unit is operated via a joystick, a series of 5 soft keys, and a push/pull/rotary ON/OFF/brightness control. The joystick allows movement of the pointer in MAP mode and is used for all forms of data entry or selection. The appropriate key labels for a



particular page are configured in software and drawn alongside the appropriate rubber key. The rotary brightness control is used for adjusting the brightness of your screen.

INITIALIZING YOUR UNIT

This procedure should have been carried out by your installer, but is included here for your reference. When outside of the hanger with a good all round view of the sky, the unit will achieve an initial position fix within 15 minutes. Ensuring that your GPS has rough UTC, date and position information can significantly speed up this process. To check this switch on the unit, select the HELP key followed by GPS STATUS.

Getting Started

Altering UTC & DATE:

Select UTC & DATE, followed by ADJUST UTC. Use the joystick to adjust the time, then press SET. Now select ADJUST DATE and use the joystick to adjust the date, and then press SET followed by GPS STATUS.

Altering Present

Position: Select SET POSN, and use the joystick to adjust the latitude and longitude to your approximate position and then press SET. Alternatively select SET POSN and then VIEW MAP.

Move the joystick on the map to your approximate position (using the ZOOM IN/ZOOM OUT keys where applicable). Once there select SET POSN.

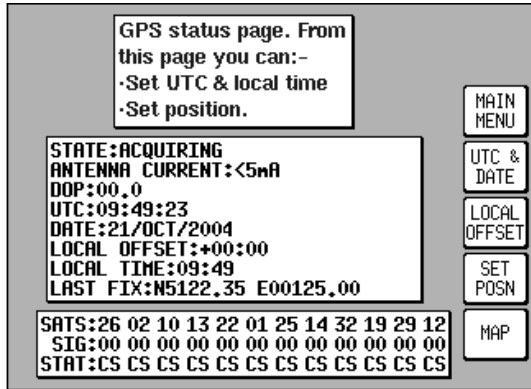

When connected to an external GPS, the KMD 150 unit will self initialize.

SOFTWARE STRUCTURE

Since the software is tree structured, an analogy can be drawn between the trunk of a tree and MAIN MENU. This can be accessed after powering on the unit and pressing the HELP key. MAIN MENU has 5 main software branches, which are as follows:

GPS STATUS / STORM-SCOPE®:

Shows satellite signal strength, allows UTC, Local Offset, Date and Position to be set. If the Stormscope® interface is switched on, shows Stormscope® screen.

FLIGHT PLAN: Allows user defined waypoints and flight plans to be edited/created (not available in External GPS Mode).

NOTEPAD: Allows accesses to NOTEPAD and E6-B functions or turns off DEMO MODE. DEMO MODE can only be activated in the first power on screen.

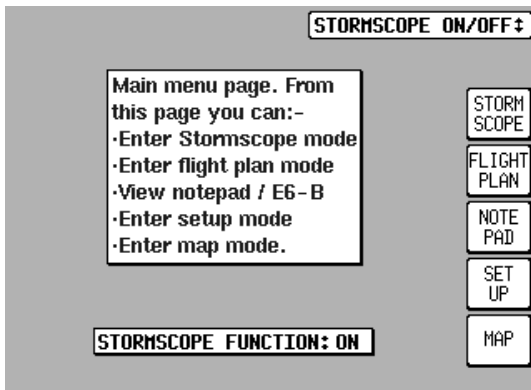

SET UP: Allows Setup of map, NAV, PIN and input/output characteristics.

MAP: This is the primary mode of the unit.

Stormscope® mode is switched on and off on this screen using the joystick.

As a rule, when trying to get to a specific function in another branch of software you should work your way back up the present branch to MAIN MENU by pressing the PREV PAGE or MAIN MENU keys. Then select the branch of software that contains the desired function you wish to access. There are, however, short cuts allowing you to get to the primary mode, MAP mode, more easily. GPS STATUS is replaced with DATA IN/OUT if the unit is set to receive external GPS data. In this case the unit will automatically be configured to accept data from the external GPS/LORAN.

SELECTING DEMO MODE

Demo Mode allows you to become familiar with handling your unit on the ground by turning it into a simulator. Demo Mode can only be activated in the first title screen, available at power on and will automatically be disabled if your unit receives valid GPS data. Press DEMO MODE in the title screen, and use the joystick to select the start LAT and

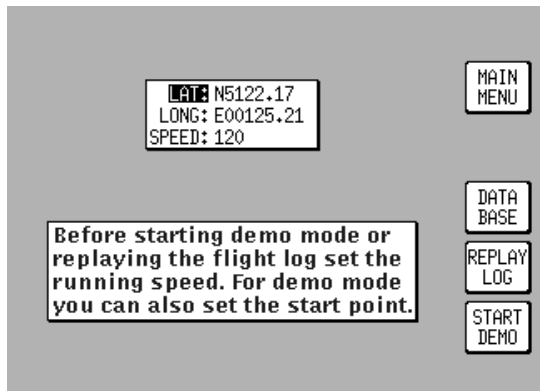

LONG and the ground SPEED you wish to use. Alternatively you can press the DATABASE key and select a data point from the database as a start point (for more information on achieving this please refer to Database Selection in this section of the manual).

Once the desired LAT/LONG and SPEED is entered press START DEMO.

Demo Mode is not available if the unit is set to receive external GPS/LORAN data.

DATABASE SELECTION

Both the internal waypoints (i.e. Jeppesen data, cities etc.) and user defined waypoints are stored in your unit in a series of databases. During normal use of your unit you will need to select items from these databases, whether it is to find out airport frequency information, or select a DIRECT TO point or when creating a Flight Plan. In each case the adjacent screen will appear. Use the joystick to highlight the database in which the desired item is contained and press SELECT.



The second stage in the selection process requires you to choose the desired item. This is achieved by using the joystick. Once the desired item is displayed press SELECT to select the item. If the item required is in an aeronautical database (i.e.: AIRPORT, VOR etc) you may well have the ability to narrow the area of search by selecting a two letter identify in the AREA field. For a complete list of two letter ICAO identifiers please refer to Appendix 2 in this manual. If the label in the AREA field says ALL then the search will include all countries available in your database card.

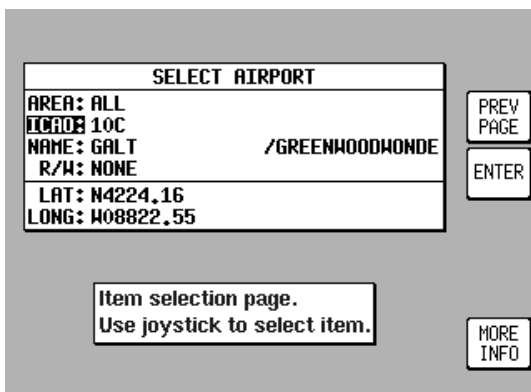

If the unit is set to receive external GPS/LORAN data, Key 2 reads MAP and returns to the map screen.

If the unit is set to receive external GPS/LORAN data, Key 2 reads MAP and returns to the map screen.

A QUICK WORD ON DIRECT TOs AND FLIGHT PLANS (NOT AVAILABLE IN EXTERNAL GPS MODE)

A flight plan is a series of legs interspersed with waypoints, while a DIRECT TO is a one leg Flight Plan. A DIRECT TO can be performed at any time. If a DIRECT TO is performed when a flight plan is active, the

flight plan will be put to sleep and the displayed navigation data in MAP mode will be to the DIRECT TO point. You will always know when a DIRECT TO is running because the DIRECT TO key will be labeled DIRECT TO OFF. Pressing this key will cancel the DIRECT TO. If a flight plan was previously running underneath it will automatically resume.

VISUAL DIRECT TO AND DATA INTERROGATION

In MAP mode use the joystick to move the pointer to the desired location, or distance/bearing from present position or latitude/longitude. If you have a ground speed your Bendix/King unit will calculate the time to reach the tip of the on-screen pointer. This information is displayed in the PETE (or Pointer ETE) field.

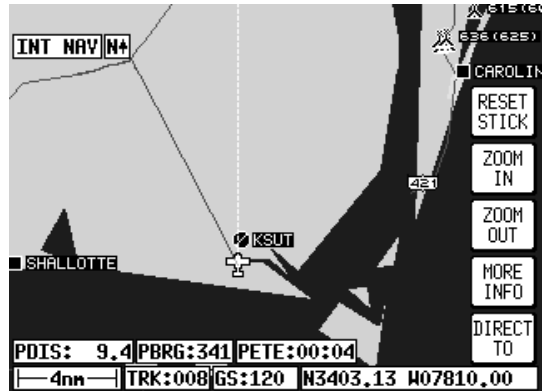

If you wish to invoke the DIRECT TO function press the DIRECT TO key (not available in External GPS Mode). The unit will then provide you with full navigation information to reach this point. Alternatively if you wish to obtain more information on a specific data point, whether it is an airport, a section of controlled airspace or a navaid, move the pointer onto it and press the MORE INFO key. Once the pointer has been activated, by pushing the joystick, it will remain active for 30 seconds; after which time it will automatically reset. Alternatively you can force a pointer reset by pressing RESET STICK.

DIRECT TO A SPECIFIC LATITUDE AND LONGITUDE

To perform a DIRECT TO a specified latitude/longitude press the DIRECT TO key in MAP mode, when the joystick is not active. Then press TEMP WPT and use the

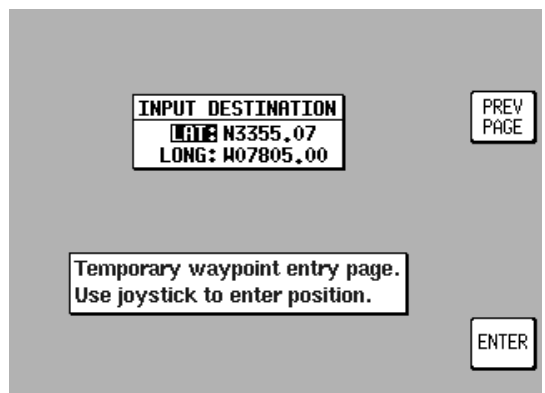

Getting Started

joystick to dial in the required latitude and longitude, followed by ENTER. The unit will then provide you with full navigation information to reach this Temporary Waypoint. This function is not available in External GPS Mode.

MANUAL DIRECT TO AND DATA INTERROGATION

Provided the pointer is not active in MAP mode, press the DIRECT TO key. You will now be able to select the item from the database as explained in Database Selection in this section of the manual. To DIRECT TO the item press the SELECT key when the desired item is displayed. To get more information on the item



press the MORE INFO key when the desired item is displayed. If you are running a DIRECT TO an item, you can discontinue the navigation by pressing the DIRECT TO OFF key. This function is not available in External GPS Mode.

EDITING/CREATING A USER WAYPOINT MANUALLY

From MAIN MENU select the FLIGHT PLAN key, followed by USER WPTS. Use the joystick to select the desired user waypoint number or name. Then press the EDIT key and use the joystick to edit the NAME, LAT and LONG fields. The entire user waypoint can be deleted by pressing CLEAR WPT. If you only wish to delete

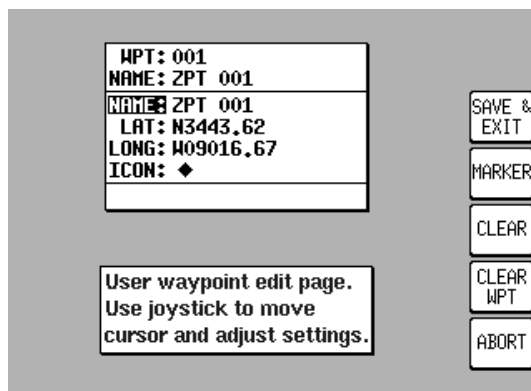

data in a particular field, as opposed to the entire user waypoint, move the cursor over the field label (i.e. NAME, LAT, LONG) and press the CLEAR key. To save a user waypoint press SAVE & EXIT.

Use the ABORT key and the PREV PAGE key to return to MAIN MENU. This function is not available in External GPS Mode.

EDITING/CREATING A USER WAYPOINT VISUALLY

From MAIN MENU select the FLIGHT PLAN key, followed by USER WPTS. You may then use the joystick to select a specific user waypoint (either by number or name). Press the VIEW MAP key and the adjacent screen will be shown with the previously selected user waypoint in the center of the screen. If the previously selected user waypoint was empty your last position will be displayed. A user waypoint can then be created as a distance and bearing from the displayed position or as a latitude/longitude. Press ENTER WPT to save the user waypoint to the first available memory location. Any user waypoint can be removed by moving the pointer over it and pressing the DELETE WPT key. If the user waypoint that you wish to delete is in a stored Flight Plan the message [PRESENT IN FLIGHT PLAN] will be displayed. A second press on the DELETE WPT key will however remove it, moving the joystick shall cancel the delete. Use the PREV PAGE key to return to MAIN MENU. This function is not available in External GPS Mode.

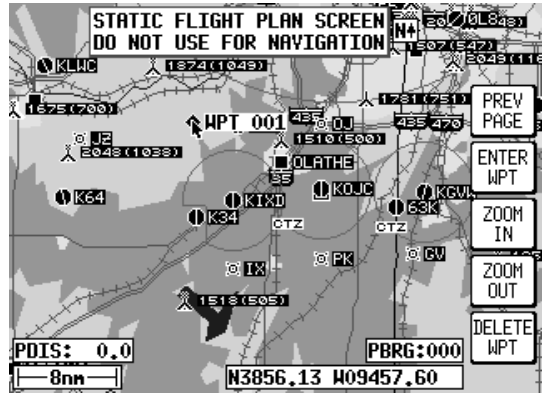

SAVING A USER WAYPOINT IN FLIGHT

A user waypoint can be saved quickly in flight by pressing NAV MENU in MAP mode followed by SAVE WPT. You will immediately be returned to MAP mode with your current position saved to the next available user waypoint memory location. This function is not available in External GPS Mode.

SELECTING STORMSCOPE® MODE

If a Stormscope® is installed the display screen can be selected from the MAIN MENU. When lightning is detected, the KMD150 will annunciate LIGHTNING in the MAP mode, to see details of the strike select MAIN MENU and STORM SCOPE to call the strike screen ranged at 200nm. From this entry screen a number of

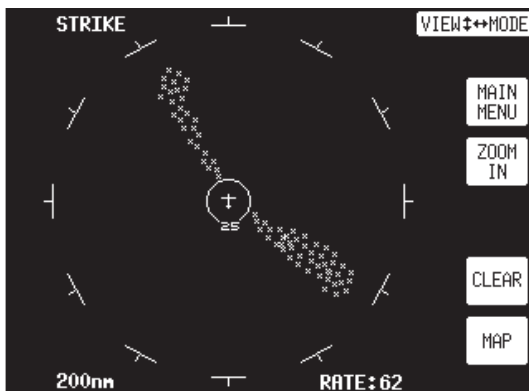

options all identified on the screen (e.g. ZOOM IN, ZOOM OUT, MODE Strike or Cell) can be selected. To clear and refresh the display press CLEAR and to return to the main navigation screen, press MAP.

EDITING/CREATING A FLIGHT PLAN MANUALLY

From MAIN MENU select the FLIGHT PLAN key, followed by EDIT FPLN. Use the joystick to select the desired flight plan number and then press SELECT. To insert an item press INSERT ITEM and follow the Database Selection process explained earlier in this section of the manual. To remove an item from

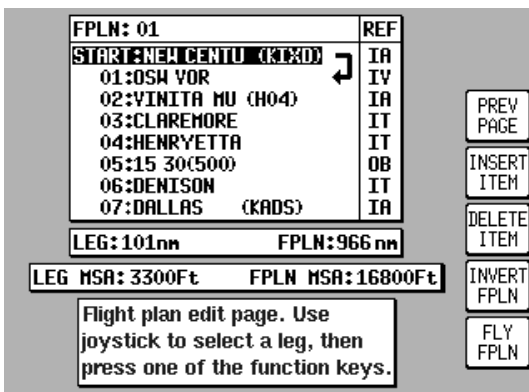

the flight plan move the cursor over the item using the joystick and press DELETE ITEM. A flight plan can be systematically built using the INSERT ITEM key. The flight plan can be inverted by pressing the INVERT FPLN key. If you wish to fly the flight plan, ensure that the flight plan arrow (shown on the side of the flight plan list) is highlighting the leg you wish to fly, the press FLY FPLN. Alternatively use the PREV PAGE key to return to MAIN MENU. This function is not available in External GPS Mode.

EDITING/CREATING A FLIGHT PLAN VISUALLY

From MAIN MENU select the FLIGHT PLAN key, followed by EDIT FPLN. Use the joystick to select the desired flight plan number and then press VIEW MAP. If the selected flight plan was empty, the adjacent screen will appear showing your last position, if it were not, the start point of the flight plan will be shown in the center of the screen. If the desired flight plan was empty you can use the joystick to move the pointer to the desired start waypoint and press



ADD WPT (ADD WayPoint). This will place an S (for Start) next to the waypoint. Move the pointer to the first waypoint and press ADD WPT again. This will place an E (for End) next to the waypoint. In either case when the ADD WPT key is pressed the unit will try to attach the waypoint to a displayed waypoint. If one is not available it will create a user waypoint in the next available memory location. To systematically create additional legs, draw a line from the waypoint marked (E), with the pointer, to the next waypoint and press ADD WPT again. You will notice that the last point in the Flight Plan will always be labeled (E). Once you have finished building the Flight Plan press PREV PAGE.

If you wish to add a new waypoint to a flight plan which you have stopped building, whether it is at the start, the end or the middle of the flight plan, you will need to highlight the appropriate point (i.e.: either the start waypoint (S), the end waypoint (E) or the leg line in which you wish to add a new waypoint). As soon as you do this, the ADD WPT or GRAB LINE key will appear. Press the ADD WPT or GRAB LINE key to join the pointer back to the flight plan line and then move it to the new waypoint. Once over the new waypoint press ADD WPT. Unwanted Waypoints can be removed by pointing at them and pressing the DELETE WPT key. Use the PREV PAGE key to return to MAIN MENU. This function is not available in External GPS Mode.

SELECTING A FLIGHT PLAN TO FLY

From MAIN MENU select the MAP key, followed by NAV MENU and FLIGHT PLAN. Use the joystick to select the desired flight plan number and then press the SELECT key. Ensure that the leg arrow is pointing at the initial leg that is to be flown and press FLY FPLN. The unit will immediately revert to map mode with the navigation information showing using the pre-selected MAP MODE. This function is not available in External GPS Mode.

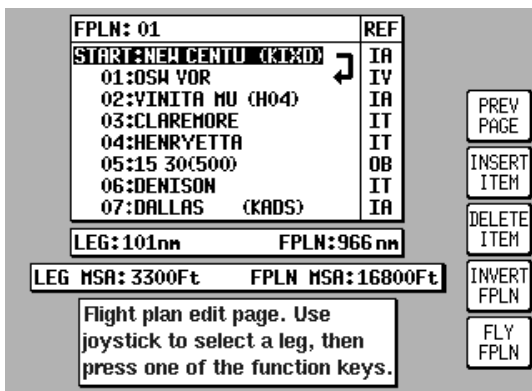

SELECTING A MAP MODE

The presentation in MAP mode can be varied from Small Text to Large Text to a CDI (Pseudo HSI) display. In all three MAP MODES there are a further two options which is either TOPO ON or TOPO OFF. In the TOPO ON mode all classes of data can be set to a specific color. In the TOPO OFF mode all cartographic data is automatically removed and the Jeppesen Nav Data is presented on a black background. The MAP MODE can be changed at any time by pressing the NAV MENU (or MAP MENU) key in MAP mode. The joystick can then be toggled until the desired selection is shown in the MAP MODE field. The new selection can be viewed by pressing MAP.

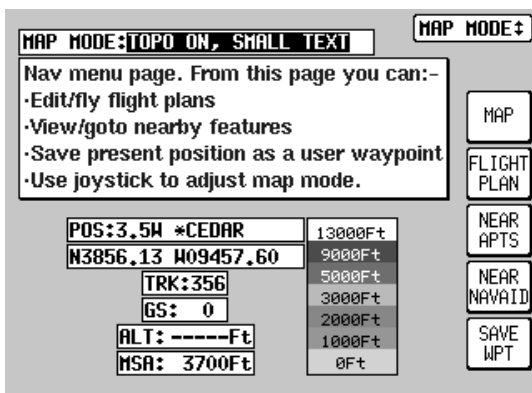

NOTE:

Large Text and CDI modes are only active when a DIRECT TO or flight plan is running.

VIEWING ETAS, DIRECT-TO ON FLIGHT PLAN

When a flight plan is running the ETA to each point in that flight plan can be viewed by pressing the DIRECT TO key on the map. On entry to the adjacent screen the cursor highlights the waypoint in MAGENTA that is currently being navigated to. If ATC clear you onto END: LAWRENCE, for example, you can use the

Direct-To waypoint function to amend the Flight Plan quickly without having to edit the Flight Plan. Use the joystick to move a BLACK highlight over END: LAWRENCE, then press DIRECT TO. This function is not available in External GPS Mode.

FPLN: 02	ETA
START:NEW CENTU (KIXD)	12:01:53
01:GARDNER M (K34)	12:02:22
02:VINLAND V (K64)	12:52:11
03:2048(1038)	13:08:26
END:LAWRENCE (KLWC)	13:22:51

ETAs / Direct-To page.
Use joystick to scroll through flight plan.

Buttons: SEL WPT+, MAP, DIRECT TO, DATA BASE

TEN NEAREST SEARCH

The ten nearest airports or navaids can be displayed by either pressing NAV MENU or DIRECT TO in MAP mode, followed by either NEAR APTS (for airports) or NEAR NAVAID (for navaids). The desired information will be presented dynamically as a bearing and distance from your present position. Any displayed item can be instantly navigated to by pressing the DIRECT TO key. Alternatively the MAP key can be used to return the user to MAP mode.

NAME	BRG	DIS
CEDAR (51K)	089	3.5
NEW CENTU (KIXD)	148	7.0
GARDNER M (K34)	174	7.7
JOHNSON C (K0JC)	112	11
VINLAND V (K64)	236	11
LAWRENCE (KLWC)	286	12
HILLSIDE (63K)	108	17

Nearest airport page.
Use the joystick to select an airport.

POS:3.5M *CEDAR

TRK:356 GS: 0 ALT: ----Ft

Buttons: MAP, PREV PAGE, MORE INFO, NEAR NAVAID, DIRECT TO

SETUP MAP FUNCTIONS

These screens allow the mapping functions to be configured. The initial screen is reached by pressing SET UP in MAIN MENU, followed by MAP SETUP. The subsequent screens are reached by pressing the NEXT key.

On the initial page each of the displayed features can be set by using the joystick. They are as follows:

ORIENTATION: Set either in Track Up or North Up.

AIRPORT NAMES: Labels airports in MAP MODE either with ICAO code, airport or city names.

MAP UNITS: Sets all map units to either nautical miles, statute miles or kilometers. If miles are selected, all lengths and altitudes will be reported in feet. If kilometers are selected, all lengths and altitudes will be reported in meters.

COORD SYSTEM: Determines whether the unit operates with reference to Lat/Long, UTM or OSGB.

LANGUAGE: Sets language to either English, French, German or Spanish.

MIN R/W LENGTH: Sets the minimum length of runway required for ten nearest airports.

ORIENTATION: NORTH UP
 AIRPORT NAME: ICAO CODE
 MAP UNITS: NAUT MILES
 COORD SYSTEM: LAT/LONG
 LANGUAGE: ENGLISH
 MIN R/W LENGTH: 01000ft
 R/W SURFACE REQ: HARD/SOFT
 EXTENDED TRACK: ON
 AUTO ZOOM: ON
 AUTO DECLUTTER: ON
 KEY BEEP: OFF
 LOGGING RATE: 030s
 POSITION REF: ALL DATA
 AIRSPACE ALERT: 5.0 nm

Map setup page.

SAVE & EXIT

RESET VALUES

NEXT

ITEM	ICON	TOPO		ICON MAX	NAME MAX	MIN	
		ON	OFF				
AIRPORTS	●	■	■	30	15	0.5	SAVE & EXIT
VORs	⊙	■	■	30	15	0.5	
NDBs	⊗	■	■	15	8	0.5	RESET VALUES
USER MPTs	◆	■	□	15	8	0.5	
INTs	▲	■	■	OFF	OFF	0.5	RESET VALUES
HELIPADS	Ⓜ	■	■	OFF	OFF	0.5	
HELIREPS	▲	■	■	OFF	OFF	0.5	NEXT
CITIES	■	■	■	15	8	0.5	
OBSTACLES	⊕	■	■	30	8	0.5	NEXT
AIRCRAFT	✈	N/A	N/A	N/A	N/A	N/A	
LOG TRAIL	OFF	N/A	N/A	N/A	N/A	N/A	

ITEM	LINE	TOPO		LINE MAX	NAME MAX	MIN	
		ON	OFF				
HEMIROUTES	---	■	■	OFF	OFF	0.5	SAVE & EXIT
MAJOR ROADS	==	■	■	N/A	15	8	
PRIME ROADS	—	■	■	N/A	8	4	RESET VALUES
OTHER ROADS	---	■	■	N/A	4	3	
RAILROADS	+++	■	■	N/A	8	N/A	RESET VALUES
RIVERS/LAKES	---	■	■	N/A	90	N/A	
V AIRWAYS	---	■	■	OFF	OFF	0.5	NEXT
TERRAIN	N/A	N/A	N/A	N/A	90	N/A	
SEA	N/A	■	■	N/A	N/A	N/A	NEXT
URBAN AREAS	N/A	■	■	N/A	N/A	N/A	
BACKGROUND	N/A	■	■	N/A	N/A	N/A	

R/W SURFACE

REQUIRED: Sets minimum runway surface required for ten nearest airports.

EXT TRACK: Turns on or off the extended track line, which is drawn ahead of your present position in the direction of your present track.

AUTO ZOOM: Turns on or off. When flying the last leg of a Flight Plan or when flying a DIRECT TO, as soon as the distance to the destination drops below 1/2 the scale bar setting, the unit automatically zooms. Auto Zoom can be disabled by simply pressing the ZOOM OUT key.

AUTO DECLUTTER: Turns on or off. If a higher priority icon label (Airport) is found to clash with a lower priority icon label (City) already on the screen, the lower priority icon label will be removed.

KEY BEEP: Turns the key beep on or off.

LOGGING RATE: Sets the rate in seconds at which you log your position and loads it into a 2000 point cyclic memory. To log a specific flight use the CLEAR LOG key, in the Clear Memory screen. (Please refer to the Clear Memory section). The flight can be replayed in DEMO MODE. (Refer to the Selecting DEMO MODE section.)

POSITION REF: Defines the reference to which your position is given in MAP MODE, either to all available data, VORs only or VORs and Airports only.

The following screens are accessed by repeatedly pressing the NEXT key. They allow you to choose the level of zoom at which you wish each of the classes of data to become visible and at which level of zoom you want their corresponding labels to become visible. You can set many of the data classes display colors for both Topo On and Topo Off display modes and also set the icon or line style for several of the data classes.

Any changes made in any of these screens will be saved once the SAVE & EXIT key has been pressed. At any time the RESET VALUES key can be pressed to return your unit to the default settings on that particular screen. If you wish to reset all setup options to their default setting press the CLEAR SETUP key in Clear Memory screen.

AIRSPACE ALERT: Defines the distance from airspace boundary at which the alert annunciation occurs or turns off this feature.

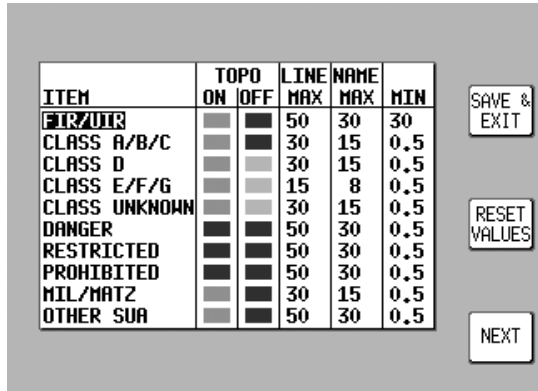

SETUP OF NAVIGATION FUNCTIONS

The adjacent screen allows the navigation functions to be configured. It can be reached by pressing SET UP in MAIN MENU, followed by NAV SETUP. This screen is not available in External GPS mode.

Each of the displayed features can be set by using the joystick. They are as follows:

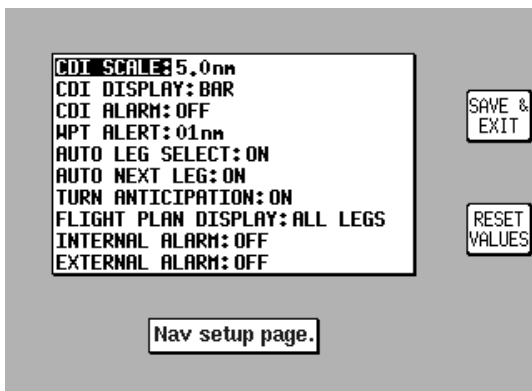

CDI SCALE: Sets the full scale deflection of displayed CDIs to 0.3, 1.0, 2.5 or 5.0nm.

CDI DISPLAY: Either turns the CDI display off, or sets it to either a numeric or bar display.

CDI AUDIO ALARM: Switches the CDI alarm on or off. When on, it is activated at full scale deflection.

ARRIVAL ALARM: Sets the distance away from your destination waypoint at which you wish the audio and visual arrival alarms to be activated. This value is always in nautical miles.

AUTO LEG SELECT: When switched on, the unit will automatically determine which is the most appropriate leg to fly when calling up a flight plan.

AUTO NEXT LEG: When switched on, the unit will automatically sequence you on to the next waypoint in a flight plan when it has deemed that the current waypoint has been passed. When switched off the user will be expected to press the NEXT LEG key in MAP MODE to sequence on to the next waypoint in the flight plan.

TURN ANTICIPATION: Turn Anticipation provides navigation along a curved path segment to ensure a smooth transition between two adjacent legs in the flight plan.

FLIGHT PLAN DISPLAY: Allows all legs in the active flight plan to be displayed or just the active flight plan leg to be displayed when flying a flight plan.

INTERNAL (ARRIVAL and CDI) ALARM: These alarms can be switched on or off.

EXTERNAL (ARRIVAL and CDI) ALARM: These alarms can be switched on or off.

Any changes made in this screen will be saved once the OK key has been pressed. At any time the RESET VALUES key can be pressed to return your unit to the default settings. If you wish to reset all setup options (including MAP SETUP options) to their default setting press the CLEAR SETUP key in the Clear Memory screen.

CLEAR MEMORY

To clear down specific parts of your units memory press SET UP in MAIN MENU, followed by INST & DIAGS and CLEAR MEMORY. You will then be asked to enter your PIN. Unit default is 1234. You are now in the Clear Memory screen. Each block of memory in your unit can be cleared down individually. CLEAR FLPNs will

remove all your flight plans. CLEAR WPTS will remove all your user waypoints. CLEAR SETUP will restore all the default settings in MAP SETUP and NAV SETUP. CLEAR LOG will clear the last flight information, the 2000 flight logged data points and all running timers.

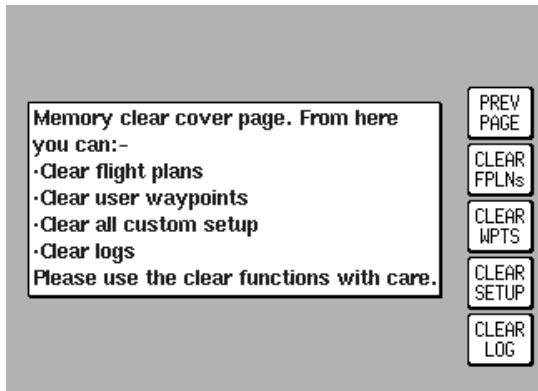

Intentionally left blank

TITLE AND HELP SCREENS

To switch the unit on, push the On/Off/Brightness control in then rotate fully clockwise.

When so configured, your unit can produce a variety of tones and alarms to assist you in correct operation. At this stage only two types of tone need concern you. These are:

- 1 short beep sounds when you press a valid key.
- 2 short beeps sound when you press a key that is not assigned.

NOTE:

KEY BEEP must be set to ON on the first MAP SETUP screen.

The Title Screen appears each time the unit is switched on. A database confirmation screen will then be displayed which you are required to acknowledge by pressing Key 1, which will be labeled OK. When you have acknowledged the validity of the database, the Title Screen will be redisplayed as shown here.

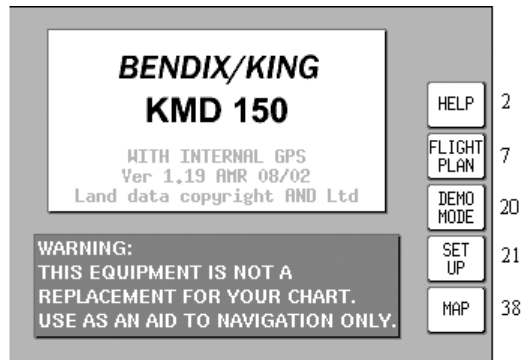

Screen 1: Title Screen

Key 1 calls Screen 2, which is the Main Menu Screen.

Key 2 calls Screen 7, which is the Flight Planning Mode Cover Screen.

Key 3 calls Screen 20, which is the Demo Mode Setup Screen. (If, since being switched on, the unit has received valid fix information from the internal GPS receiver, Key 3 DEMO MODE will for safety reasons default to NOTE PAD and call screen 62. This also applies if the unit is set up to receive external GPS/LORAN data. This is the only Screen on which Demo Mode can be activated.

Key 4 calls Screen 21, which is the Setup Cover Screen.

Key 5 calls Screen 38, which is the Map Mode Screen.

To switch the unit off, pull the On/Off/Brightness control.

WARNING:

Do not try to force the control knob past its end stops.

SELF TEST AND INITIALIZATION

When the Title Screen is initially displayed, no key labels are drawn while a series of internal check routines are carried out automatically by the unit. These are:

1. Verification that the unit has been factory initialized. This consists of a check to see if there is a special code in NVM. If there is no initialization code in the NVM a message saying UNIT NOT INITIALIZED will be printed across the center of the Screen and the unit will be totally disabled. This is a security feature, safeguarding against theft of the unit and attempted erasure of your PIN from the NVM. (If your unit is stolen and the NVM is erased or replaced in an attempt to reset the PIN, the thief will still not be able to use or sell the unit because these special high security factory initialization codes will be missing.)
2. A check for RAM corruption. If RAM has been lost or corrupted due to a severe 'glitch' or loss of power in the memory battery a RAM clear will be performed on the affected areas and Screen 51, Ram Lost Warning Screen, will be displayed (Refer to Appendix 1).
3. A check of the internal Lithium battery voltage. If the internal battery voltage is low, Screen 52, Internal Battery Warning Screen, will be displayed (Refer to Appendix 1).
4. A check to see whether the Automatic Power-On Lock function has been enabled (see Screen 26 for further details). If it is enabled, Screen 54, Power On Security PIN Entry Screen, will be displayed after 5 seconds (or if any key is pressed before this). If when switched on it is found that three unsuccessful attempts have been made to enter the Unlock PIN, Screen 55, Lockout Screen, will be displayed (Refer to Appendix 1).
5. A check to see if a new database card has been fitted. This involves comparing the software version number held in NVM with that of the current database Card. If a change of card is detected, the integrity of all Flight Plans will be checked and if any discrepancies are found Screen 56, Flight Plan Change Warning Screen, will be displayed (Refer to Appendix 1).
6. The internal GPS receiver circuitry will be tested and if any problems are found, a NO REPLY message will be indicated in the STATUS field of Screen 3, GPS Status Screen.

If the unit passes the 6 previous checks no warnings will be given, the key labels will be drawn.

MAIN MENU SCREEN

If set up for internal GPS use, Key 1 calls Screen 3, which is the GPS Status Screen. The joystick can be used on this screen to switch the L-3 Communications WX-500 Stormscope® interface on and off. If Stormscope® is switched on, Key 1 will be labeled STORMSCOPE and will cause the Stormscope® screens to be displayed. GPS data screens can

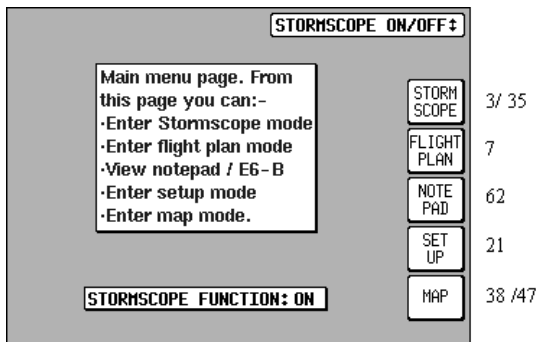

Screen 2: Main Menu Screen

still be accessed in this case through the INST & DIAGS key under SETUP or by switching the Stormscope® interface off using the joystick. Key 2 calls Screen 7, which is the Flight Planning Mode Cover Screen (not available in External GPS Mode). Key 3 will read NOTE PAD if DEMO MODE was not selected on Screen 1. Pressing Key 3 will call screen 62, which is the NOTE PAD display screen and will also give access to Screen 57, which is the E6-B Calculator Cover Screen (Refer to section on E6-B Calculator). If Demo Mode has previously been activated, Key 3 will read DEMO OFF. Pressing DEMO OFF will then switch Demo Mode off and return to Screen 2 with Key 3 reading NOTE PAD. Key 4 calls Screen 21, which is the Setup Cover Screen. Key 5 calls Screen 38 or 47, which are Map Mode and Map Mode with NAV Information Screens.

NOTE PAD SCREEN

The Note Pad Screen (Screen 62) is accessed by pressing Key 3 on Screen 1 or Screen 2, Main Menu Screen.

The Note Pad function allows you to load up to 4000 characters of text into your GPS unit from a personal computer running suitable flight planning software. This text can then be recalled on a special Note Pad screen during flight.

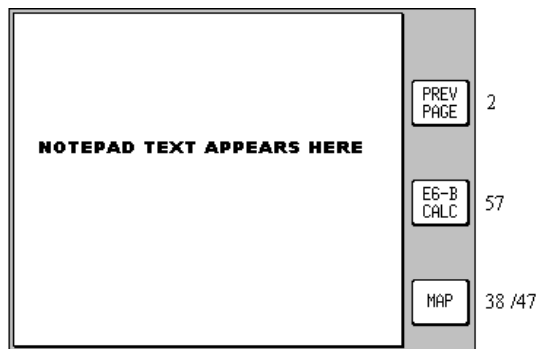

Screen 62: Notepad Screen

Title and Help Screens

The Note Pad text can contain any information you want. Typical uses include check lists, enroute weather downloaded before the flight from DUATS, special instruction for an unfamiliar destination etc. Using the 'Flight Manager' software from Honeywell you can prepare and store a library of Note Pad files and load the relevant one into your KMD 150 unit to suit your day's flying.

Screen 62 also gives access to the E6-B Calculator Screens.

GPS STATUS SCREENS

This Screen is only accessible if Internal GPS source is selected and is accessed by pressing Key 1, GPS STATUS, in Main Menu.

The GPS Status Screen will display the receiver STATUS. This can be any of the following:

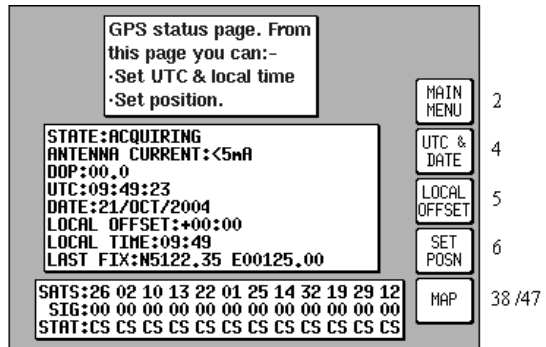

Screen 3: GPS Status Screen

BAD ALMANAC
2D FIX

<3 SATS
3D FIX

DIFFERENTIAL
POOR DOP

ACQUIRING
POS PROP

The meanings of these displays are:

BAD ALMANAC means the GPS receiver's information concerning satellite positions is out of date. If this occurs the unit should be left alone with the antenna connected and in view of the sky for approximately 15 minutes during which period it will automatically lock onto a satellite and load an up-to-date almanac.

<3 SATS means that according to the current information available, there are less than three satellites in view and a fix can not be calculated. This message is very rarely displayed.

DIFFERENTIAL This word will be displayed in conjunction with 2D FIX or 3D FIX and means that the KMD 150 has a fix and is also receiving differential correction signals from an external source. (Refer to Appendix 4 for further details concerning differential operation.)

ACQUIRING means the unit is currently searching for satellites or is loading information from one or more satellites.

2D FIX means the unit is calculating position in two dimensions (i.e. latitude and longitude only, with no height information).

3D FIX means that the unit is calculating position in three dimensions and can give latitude, longitude and height information.

POOR DOP means that the unit is unable to calculate position owing to the poor geometry of the visible satellites. (DOP stands for Dilution of Precision.)

POS PROP means that navigation has been temporarily lost and the KMD 150 is dead-reckoning (or propagating) its position based on the last known position, track and ground speed. It will not dead-reckon for more than a few seconds at a time.

Other information that is displayed, on this Screen includes:

ANTENNA CURRENT Against this heading there will be an indication if the antenna is drawing too much, too little or the correct amount of current. If the indication is <5mA then the antenna is probably open circuit and must be investigated. If the indication is >40mA then the antenna is probably short circuited and must be investigated. If the indication is OK then the antenna is drawing the correct amount of current.

DOP (Dilution of Precision), this is a number between 00.0 and 99.0 that represents the dilution of quality of the calculated fix due to satellite geometry. 00.0 is best, 99.9 is worst. If this figure is greater than 5.0, performance of the system is likely to be degraded because some of the visible satellites appear too close to each other. DOP is calculated from the angular separation between the various visible satellites. Greater separation results in better fix geometry and a lower DOP. (This DOP figure is not measured in any specific units.)

UTC/DATE, which is Universal or Greenwich Mean Time and Date.

LOCAL OFFSET, which is the difference between UTC and local time.

LOCAL TIME, which is calculated by adding Local Offset to UTC.

LAST FIX. If the unit does not have a current valid fix, this is the position at which it last had a fix. If the unit has a fix, this is the present position.

SATS (eight satellite numbers), **SIGS** (signal strength for each satellite) and **STAT** (status of each satellite).

Each satellite has a PRN (Pseudo Random Noise) or identification number. The satellite PRN numbers are displayed in a line beside the word SATS. The two digit number under each PRN number is an indication of the signal strength being received from that satellite expressed in terms of a percentage. Best is 99, worst is 00. These numbers can be used for finding and eliminating electrical interference. Readings of 60 and above indicate a good installation.

Under each signal strength number is a two character code. These indicate the status of each satellite. These codes are: CS, CA, AS, FA, BD, MD, TA, EA, and AP. These relate to the eight possible receiver modes and are detailed in the next paragraphs.

CS: Code Search. This is the receiver's initial stage in acquiring a satellite. It means that the receiver is trying to match its internal code to the satellite signal.

CA: Code Acquire. This means the satellite code has been received and matched to the receiver-generated code.

AS: AGC Set. This means the satellite strength has been assessed and the Automatic Gain Control has been set.

FA: Frequency Acquire. This means the receiver has correctly locked onto the satellite data frequency.

BD: Bit Sync Detect. This means the receiver is synchronized with the satellite's data bit stream.

MD: Message Detect. This means the receiver is synchronized with the satellite's message stream.

TA: Time Available. This means the satellite is fully locked in and has sent down UTC time and date information to the receiver.

EA: Ephemeris Acquire. This means the receiver is reading the constellation health status message from the satellite. This usually takes around two minutes and is a function that is performed in the background even if the receiver has a fix.

AP: Available for Position. This means the satellite is fully locked in and tested and can be used for calculating position. A minimum of three satellites are necessary for a 2D fix.

Key 1 returns to Main Menu. Date, Time, Local Time Offset and Present Position can be adjusted by selecting one of Keys 2, 3 or 4. Direct access to Map Mode is available by pressing Key 5.

When using the KMD 150 for the first time (or after it has been relocated by more than 100 miles since it was last used) setting up the present position (to within 50 miles or so) and ensuring that UTC and Date are correct (to within a few minutes) will considerably speed up the TTF (time to first fix). It is not absolutely necessary to do this, since given time, the receiver is quite capable of working out its own position.

ADJUSTING TIME AND DATE

Pressing GPS STATUS in Main Menu followed by UTC & DATE accesses this Screen. The UTC & DATE key will only be available until the GPS has acquired the correct time from a satellite. Pressing Key 3, ADJUST UTC, places a cursor over the first digit of the Hours value on the time display. The value can then be increased or decreased by moving the joystick up or down.

Pushing the joystick to the right then moves the cursor to the next digit. Similarly, the cursor can be moved back along the data entry field by moving the joystick left. When the time is adjusted, the information will only be saved if you press Key 1 SET.

Pressing Key 4 puts a cursor onto the Date entry field. The date is adjusted in the same way as time. With the cursor over the Month when the joystick is moved up or down, the first three characters of each month are scrolled together i.e. JAN, FEB, MAR, APR etc. Adjusting the year works in the same way. Your KMD 150 unit is fully Year 2000 compliant. Only after pressing Key 1 SET is the new date saved. The Time and Date will be automatically corrected as soon as the first satellite reaches TA (time available) status. If any satellite is already at status TA or above, user inputs of time and date will be ignored.

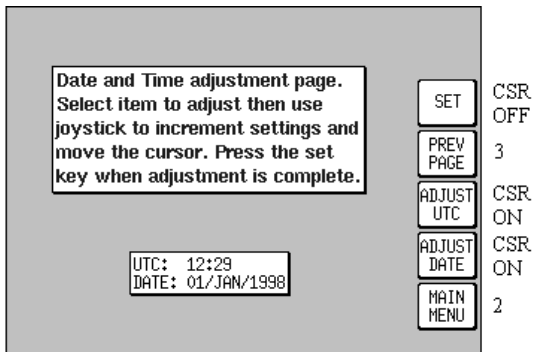

Screen 4: Date and Time Adjustment Screen

SETTING LOCAL TIME OFFSET

Pressing GPS STATUS in Main Menu, followed by LOCAL OFFSET, accesses this Screen. When this Screen initially appears a cursor will be active in the data entry field. The hour's value can be adjusted between the limits of +12 and -12 by using the joystick.

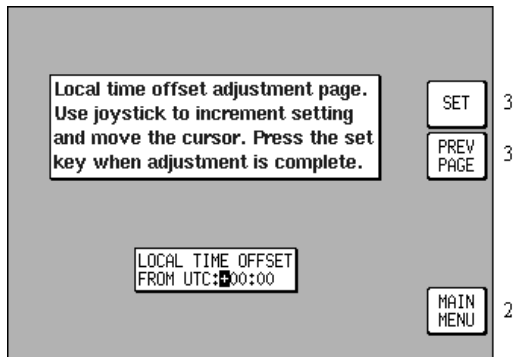

Screen 5: Local Time Offset Screen

The cursor can then be moved to the right to adjust the minutes to one of two values, 00 or 30. Only after pressing Key 1 SET is the information saved and the display reverts to Screen 3, GPS Status Screen.

The local offset is held in RAM and added to UTC time when calculating ETA's. Default value is +00:00. It is important to set local offset correctly to ensure ETA's given in NAV Mode are correct.

SETTING PRESENT POSITION

Pressing GPS STATUS in Main Menu, followed by SET POSN, accesses this Screen. The SET POSN key will not be available if the GPS has acquired a position fix. On entry to this Screen a cursor is positioned over the first character of the latitude as shown here. The joystick can then be used to increment or decrement values and to move the cursor right and left.

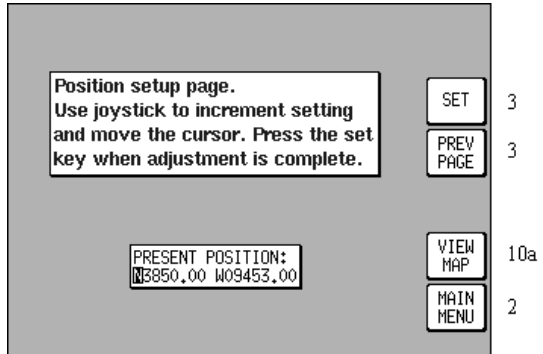

Screen 6: Present Position Setup Screen

When new values for latitude and longitude have been selected, pressing Key 1 SET will enter the new latitude and longitude and revert to Screen 3.

Alternatively you can press Key 4 VIEW MAP and using the joystick, simply point at your present position.

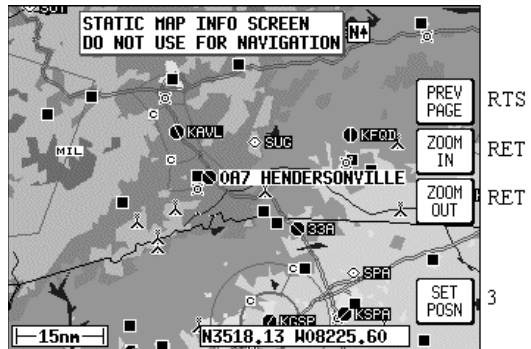

Screen 10A: View Map Screen

When Screen 10A is displayed you can zoom in or out using Keys 2 or 3. By using the joystick you can 'bump' the borders of the map window to view anywhere in the world. The POS: box at the bottom of the screen displays the latitude and longitude of the pointer.

Once you have the joystick pointing at your present location, press Key 5 SET POSN to return to Screen 3, where the pointer latitude and longi-

GPS Status Screens

tude will then be fed into the LAST FIX field.

To leave the position unchanged press key 1, PREV PAGE which will return you to Screen 6.

If the unit is receiving sufficient satellite signals to calculate a fix, user-entered latitude and longitude will be ignored.

DATA INPUT (EXTERNAL GPS MODE)

If you own the non-GPS version of KMD 150, or as an alternative to using the internal GPS receiver, your KMD 150 has been wired to accept data from a remote GPS or LORAN unit, you will be operating in External GPS Mode and this section applies to you. The following text is an overview only and is valid for the non-GPS KMD 150 or the full GPS version if set to external GPS source. Refer to the KMD 150 Installation Manual for further details.

To operate correctly from an external data source, your KMD 150 requires a 1200, 4800 or 9600 baud Bendix/King equivalent ARNAV R-30 (RS232) data sentence. Alternatively a 1200, 4800 or 9600 baud NMEA 0183 data sentence containing latitude, longitude, track, and ground speed information may be used. This can take the form of a single RMC sentence or a combination of GGA and VTG sentences. A third alternative data input is the Northstar M3 binary data format at 1200 baud.

Once the physical connection to the host GPS or LORAN has been made, it is essential to select an appropriate data output on the host unit. This can be done by referring to the manual for the host GPS/LORAN and choosing an option that corresponds to one of the compatible data input types listed previously. Your installer should have carried this out.

Once a suitable data output type has been selected on the host GPS/LORAN and it has a fix, switch on your KMD 150. If the host GPS or LORAN is correctly connected, switched on and outputting data, your KMD 150 will automatically start to read and decode the incoming data. There is no need to set an input type on the KMD 150 as this is done automatically.

DISPLAY OF HOST FLIGHT PLAN DATA

BENDIX/KING DATA FORMAT

If the host GPS is outputting data in the Bendix/King equivalent ARNAV R-30 (RS232) data sentence format, in LEG mode, the active flight plan will be sent to the KMD 150 and will be displayed automatically when in Map Mode. An exception to this is during the curved flight segments of approaches (i.e. DME arcs, procedural turns and holds) when most GPS units stop outputting flight plan data but continue to output positional data. During a DME arc or procedural turn, the KMD 150 will continue to show position, track and ground speed but the curved line depicting the arc or turn will not be displayed. In OBS mode, some GPS units will not be able to provide flight plan data. Present position is still provided and flight plans will be displayed as soon as the mode is returned to LEG.

Important Note for Garmin GPS Users

Although Garmin products output the Bendix/King equivalent ARNAV R-30 (RS232) data sentence format, when put into OBS Mode some Garmin GPS units stop sending flight plan data. In these circumstances your KMD 150 will display only the GPS position and track since it is not receiving flight plan data.

In the case of DME arcs, turns and holds, some Garmin GPS units send the flight plan information as if there was no arc or curved flight path. Therefore the KMD 150 has no option but to connect the beginning and end waypoints of the arc or curve with a straight line. Under these circumstances the line on the KMD 150 MUST BE IGNORED.

NMEA AND NORTHSTAR DATA

If the host GPS is outputting NMEA data or Northstar M3 binary data, no flight plan information will be displayed on the KMD 150. The information appearing on the KMD 150 will be limited to present position, track and ground speed.

FLIGHT PLANNING SCREENS

These screens are not available in External GPS Mode. In order to allow you to navigate along pre-planned Flight Plans, your KMD 150 has facilities to memorize up to 500 user waypoints. Using these user waypoints together with the enormous built-in database you can then plan up to 99 Flight Plans. The maximum length of each flight plan is limited only by the total number of flight plans stored. The equipment has a capacity to store up to 500 flight plan points with a maximum number of waypoints in any one flight plan of 99.

For example, you can program 99 flight plans, each with 5 waypoints making a total of just under 500 flight plan waypoints or you could program 5 flight plans each with 99 waypoints. If you attempt to exceed 500 waypoints the unit will display a FLIGHT PLANS FULL message.

For simple single-leg navigation there is a useful "direct to" or DIRECT TO navigation mode. This allows you to fly from your present position directly to any point in the world. More details about this function are discussed in the Map Mode Screens Section of this manual.

All user waypoints and flight plans are normally programmed before embarking on the trip and stored in the unit's user waypoint and flight plan library.

USER WAYPOINTS

A user waypoint is a specific location anywhere in the world, defined by an icon, a name of up to nine letters or numbers and by a latitude and longitude. In your KMD 150 there are three types of user-defined user waypoints, each with a specific function.

BASIC USER WAYPOINTS

These are purely user-defined points. These are used in flight plan building, along with data points from the internal database, or simply to add personalized points to your map. A large choice of icon styles are available.

MARKER USER WAYPOINTS

Marker User Waypoints are also user-defined waypoints. These can be configured to act as alarm trigger markers. For example, say you are flying a Flight Plan and you know you have to make a radio call or initiate a climb at a specific point. A Marker User Waypoint can be positioned at that location (but not included in the Flight Plan) and be set up to trigger an alarm. If a user waypoint is to be used as an alarm trigger, when it is programmed it is given the name MARKERX.X (by pressing the MARKER key). The word MARKER here specifies to the software that this user waypoint is to be used as a marker point only and that no name

is to be printed next to the user waypoint icon on the map. The X.X specifies the alarm trigger distance between 0.1nm and 9.9nm. The default is 1.0nm. A circle of the specified radius will appear around the marker point on the map.

While the KMD 150 software is searching to locate the nearest items for conventional position reporting, if it pulls up a user waypoint named MARKERX.X, it will continuously compare the distance from the present position to the Marker User waypoint with the value X.X. When the distance to the Marker becomes less than or equal to X.X then an audible alarm will be triggered. A box will also appear at the top of the screen showing MARKER IMMINENT. Key 5 will change to ALARM OFF and when pressed, will silence the audio alarm and remove the MARKER IMMINENT message.

Should you wish a Marker waypoint to have a name next to it for reference, you simply program a Basic User Waypoint with the same co-ordinates as the Marker and give this one a conventional name. The Basic and Marker User Waypoint icons would then be superimposed on each other, resulting in a single, named Marker User Waypoint.

USER DEFINED AIRPORTS

Owing to the fact that many private and unlicensed airports are not included within the Jeppesen database contained within your unit, you have the opportunity to program up to 25 of your own USER DEFINED AIRPORTS. User waypoints numbered 101 - 125 have been reserved for this purpose and whenever any of these is selected for editing on Screen 8, User Waypoint Viewer Screen, Screen 8A will be displayed instead. This Screen allows the insertion of additional information so permitting 25 user waypoints to become user-defined airports. These will be shown on the map pages with an airport icon instead of a user waypoint icon. The user-defined airports will also be included in the ten nearest airports search on Screen 43, Ten Nearest Airports Screen, and will receive equal priority with other database airports for position reporting purposes.

On Screen 39, Map Mode with Joystick Active Screen, if the pointer is placed over a user-defined airport and the MORE INFO Key is pressed, Screen 40, Map Mode Airport Information Screen, will be displayed with the data you have entered being displayed.

Pressing **Key 2**, FLIGHT PLAN, in Main Menu, accesses this Screen.

Key 1 returns to Main Menu.

Key 2, EDIT FPLN, gives access to flight plan creation and editing pages.

Key 3, USER WPTS, gives access to user waypoint creation and editing pages.

Key 4 has no function.

Key 5 gives direct access to the current Map Mode.

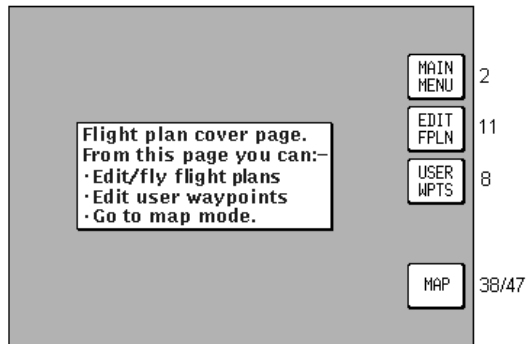

Screen 7: Flight Planning Mode Cover Screen

VIEWING USER WAYPOINTS

Pressing FLIGHT PLAN in Main Menu, followed by USER WPTS, accesses this Screen. When this Screen appears a cursor will be seen positioned over the WPT field. Use the joystick to increment or decrement the user waypoint number. (Holding the joystick up or down will increase the speed of these changes.) Alternatively the joystick

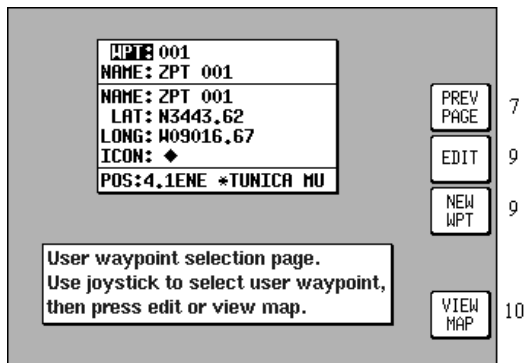

Screen 8: User Waypoint Viewer Screen

can be used to select a user waypoint alphabetically by name in a similar fashion by moving the cursor down to the NAME: field.

As each user waypoint is selected, the name, latitude, longitude, icon and position fields are updated. Empty user waypoints will be shown with dashes in the latitude and longitude fields and the default icon (see Screen 22A, Point Features Data Class Setup Screen, in the Setup Screens Section of this manual for details on setting up the default icon style).

As each user waypoint is selected, all stored flight plans are automatically checked to see if that user waypoint is being used in any current flight plan. If the user waypoint is found within any of the flight plans, the

Flight Planning Screens

words [FPLN LINK] will be printed next to the user waypoint number. It is necessary to think carefully before editing any user waypoint marked FPLN LINK since any changes you make to the user waypoint are liable also to affect one or more of the programmed flight plans.

If a user waypoint marked FPLN LINK is selected for editing and the Name only is changed, the new name will be copied over to the relevant parts of the flight plan list. If the name is left the same and the Latitude and/or Longitude only is changed, the new details will also be copied into the flight plan list. However, if the Name is changed, along with either the Latitude or Longitude the user waypoint will be treated as completely new and the details will not be copied to the flight plan list.

This would result in your being left with waypoints in your Flight Plans that do not exist as user waypoints. This can be beneficial in some cases as it makes it possible to double the number of user points in the system to 1000, but it is essential to understand this feature thoroughly and to use it carefully.

Key 1 will return to the main Flight Planning Mode Cover Screen. Once a user waypoint has been selected, Key 2 gives access to the Manual User Waypoint Editing facilities. Key 3, NEW WPT shall invoke the Manual User Waypoint editing with the next available empty waypoint. Key 5 displays Screen 10, which is the Graphical User Waypoint Editing Screen. This shows a map on which the selected user waypoint is central. If the selected user waypoint is empty, the map will default to the last fix position.

MANUAL USER WAYPOINT EDITING

Pressing FLIGHT PLAN in Main Menu, followed by USER WPTS and EDIT, accesses this Screen. On entry to this Screen a cursor appears over the word NAME. The cursor can be moved up and down between NAME, LAT, LONG and ICON using the joystick. The joystick is again used to move the cursor to the right so that the user waypoint name, latitude, longitude and icon type can be entered or amended, again by using the joystick.

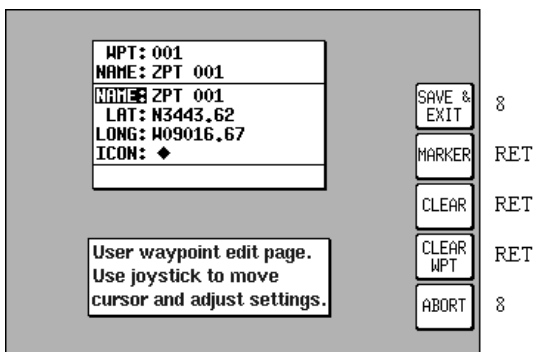

Screen 9: Manual User Waypoint Edit Screen

When the cursor is moved to the right after the last character in a line, the POS field will be updated and the cursor will move to the next line heading. i.e. from the last character in the name, the cursor will go to the word LAT and similarly from the last digit of the longitude it will go to the word ICON.

If you want to use the selected user waypoint as a marker as described previously, pressing Key 2, MARKER, will automatically write the word MARKER1.0 into the name field. You can then move the cursor across using the joystick and alter the distance and fill in the latitude and longitude. If you want to delete an existing user waypoint, press Key 4. If you want to delete just the data entry field that the cursor is positioned over, press Key 3, CLEAR.

When the desired alterations have all been made, touching Key 1, SAVE & EXIT, will enter the revised data and return you to Screen 8, User Waypoint Viewer Screen. Alternatively, touching Key 1, ABORT, will return you to Screen 8 without modifying the user waypoint information, canceling all the changes you have made.

GRAPHICAL USER WAYPOINT EDITING

When this Screen first appears, after pressing VIEW MAP on Screen 8, User Waypoint Viewer Screen, the selected user waypoint will be centrally positioned. The joystick can be used to move the pointer. The screen window can be moved around to display other areas of the map by "bumping" the screen

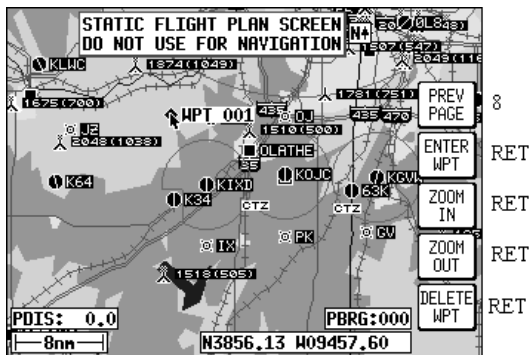

Screen 10: View and Edit User Waypoints on the Map Screen

borders left, right, up or down with the pointer. If you need to "bump" the screen over a large distance you will find it quicker and easier to zoom out first, move across the map as required. Then zoom back in (In order to make these moves swiftly, not all details of the map are shown on screen until the joystick is released.)

Distance and bearing boxes below the map show distance and bearing from the selected user waypoint (or the last user waypoint entered) to the pointer. This feature allows you easily to enter new user waypoints as a distance and bearing from a previously entered user waypoint.

Flight Planning Screens

New user waypoints can be created wherever the pointer is placed simply by pressing Key 2, ENTER WPT. Existing user waypoints can be deleted by positioning the pointer directly over them and then pressing Key 5, DELETE WPT. Should you attempt to delete a user waypoint that is being used in a stored Flight Plan, the [PRESENT IN FLIGHT PLAN] message box will be displayed and the user waypoint will NOT be deleted. Pressing Key 5, DELETE WPT, a second time will then delete the user waypoint. Alternatively, moving the joystick while the [PRESENT IN FLIGHT PLAN] message box is displayed shall result in cancelling the delete command.

Each new user waypoint graphically created on the map will automatically be given the next available user waypoint number as a temporary name and the default icon but you can alter the name and icon later by using Screen 9, Manual User Waypoint Edit Screen.

EDITING USER AIRPORTS

Whenever you select a user waypoint number between 101 and 125 in Screen 8, User Waypoint Viewer Screen, Screen 8A, User Airport Edit Screen, will be displayed. This is similar to Screen 8 but contains data entry fields where you can enter and store additional information about the airport's main runway and frequencies.

WPT: 001 USER AIRPORTS	
NAME:	
NAME:	ELEV: +00000Ft
LAT: -----,--	MAIN: 00/18
LONG: -----,--	LENGTH: 00000Ft
APPR: 118,00	SURFACE: SOFT
TOWER: 118,00	LIGHTING: NO

User waypoint selection page.
Use joystick to select user waypoint,
then press edit or view map.

PREV PAGE 7
EDIT 9
NEW WPT 9
VIEW MAP 10

Screen 8A: User Airport Edit Screen

FLIGHT PLANS

The flight plan function allows you to store up to 99 flight plans, as explained earlier in this section. These flight plans can be recalled from memory and flown in Map Navigation Mode. You can choose to use as waypoints any waypoints from the built-in

FPLN: 02	
START: CEDAR (51K)	
01: NEW CENTU (KIXD)	
02: GARDNER H (K34)	
03: WPT 010	
04: VINLAND V (K64)	
05: 2048 (1038)	
END: LAWRENCE (KLAC)	

Flight plan select page.
Use joystick to select flight plan,
then press one of the function keys.

PREV PAGE 7
SELECT 12
TRIP/FUEL 60
VIEW MAP 19

Screen 11: Flight Plan Selection Screen

database (which is subdivided and arranged alphabetically) and also, if you wish, from your own list of user waypoints.

Pressing FLIGHT PLAN in Main Menu, followed by EDIT FPLN, accesses this Screen. As you enter this Screen you will find a cursor positioned over the flight plan number. The first few items of the selected flight plan are displayed in the box under the flight plan number together with the final (destination) item. You can then use the joystick to select other flight plans. Use the same technique as was described earlier for selecting user waypoint numbers. Once you have selected the flight plan you wish to edit, pressing Key 2, will allow you to manually edit it.

Key 1, PREV PAGE, returns you to the Flight Planning Mode Cover Screen. Key 5, VIEW MAP, calls Screen 19, enabling you to edit the selected flight plan graphically on the map.

Key 4, TRIP/FUEL gives access to the trip and fuel planning function. For more information on this function please refer to the Trip/Fuel Planning information in the E6B Calculator Section of this manual.

If you happen to access the previous Flight Plan Selection Screen while a flight plan is active and you subsequently dial up the active Flight Plan number, you will find Key 5 changes to FPLN OFF and Key 1 goes blank. As a safety measure the system will not allow you to edit the active Flight Plan directly unless you touch Key 5, FPLN OFF. This will switch the Flight Plan out of active status and re-enable Key 1 allowing you to edit what was until then the active Flight Plan.

MANUAL FLIGHT PLAN BUILDING AND EDITING

This Screen can be accessed either through the Flight Planning Mode Cover Screen (by pressing FLIGHT PLAN in Main Menu followed by EDIT FPLN and SELECT) or through the NAV Menu Cover Screen (by pressing NAV MENU in Map Mode followed by FLIGHT PLAN). For more information on the second form of entry to this Screen see Screen 41, NAV Menu Cover Screen, in the NAV Menu Screens Section of this manual.

FPLN: 01	REF
START: NEW CENTU (KMD)	IA
01: OSM VOR	IV
02: VINITA MU (H04)	IA
03: CLAREMORE	IT
04: HENRYETTA	IT
05: 15 30(500)	OB
06: DENISON	IT
07: DALLAS (KADS)	IA

LEG: 101nn	FPLN: 966nn
LEG HSR: 3300ft	FPLN HSR: 16800ft

Flight plan edit page. Use joystick to select a leg, then press one of the function keys.

PREV PAGE	11 /42
INSERT ITEM	13
DELETE ITEM	RET
INVERT FPLN	RET
FLY FPLN	47

Screen 12: Flight Plan Program/Edit Screen

Flight Planning Screens

When you enter this Screen you will find a cursor positioned over the first item in the chosen flight plan. By using the joystick, you can move the cursor up or down. This enables you to scroll in either direction through the entire flight plan in the display box.

Next to each waypoint in the column headed REF you will see a two-character code that gives the database origin of each point in the flight plan. The meanings of these codes are as follows:

IA (Internal Jeppesen Airports); IV (Internal Jeppesen VORs); IN (Internal Jeppesen NDBs); IR (Internal Jeppesen Runways); IT (Internal Towns); II (Internal Jeppesen Intersections/Approach Waypoints); WP (current user waypoint {if user waypoint link is present}); OW (Old user waypoint {if user waypoint link has been broken}); UA (User Airport {user waypoint numbers 101-125}) and PC (external data down loaded from a PC).

In the example shown in the illustration for Screen 12, moving the joystick down would move the cursor down over 01 (or destination of leg 1) but would leave the "LEG" arrow positioned as it was. The distance shown next to the word LEG also would remain unchanged, showing the leg distance from the flight plan start point to Waypoint 01. Moving the joystick down again would move the cursor down to 02, move the leg arrow down so that it is pointing between 01 and 02 and the figures next to the word LEG would then show the distance from 01 to 02 and so on. The number next to the word FPLN is the total flight plan length from start to finish.

In addition, as the cursor is moved up and down the Flight Plan, the MSA for that leg is shown in a box below the LEG and FPLN info box as [LEG MSA: XXXX]. This value is the highest Grid MORA found along a ten mile wide corridor (including five miles past the waypoint) centered along each leg. Also shown is the [FPLN MSA: XXXX], which is the highest value leg MSA for the entire flight plan.

An extra waypoint can be inserted at any place in the flight plan (assuming the flight plan is not full). To do this, you position the cursor over the appropriate point in the flight plan and press Key 2, INSERT ITEM. For example, if you placed the cursor over 02, the new item would become 02 and the existing 02 would become 03, etc. In a similar manner items may be deleted from the flight plan by positioning the cursor and pressing Key 3, DELETE ITEM. Key 4 inverts or reverses the flight plan. Key 5, FLY FPLN, throws the unit into Map Mode (Screen 47) with the selected flight plan active.

MANUALLY INSERTING A WAYPOINT INTO A FLIGHT PLAN AND MANUAL DIRECT TO

A Waypoint can be inserted into a flight plan by using a two step process that is started by pressing Key 2 INSERT ITEM. The same process is followed when Key 5 DIRECT TO is selected in Screen 38, Map Mode when the joystick is not active and a Flight Plan is not running. The same process is also followed when Key 5 DATABASE is selected in Screen 41A.

SELECTING DATA SOURCE

This Screen shows a list of data libraries and you will find a cursor positioned over the word AIRPORTS. You can use the joystick to move the cursor up and down the list of databases. Keys 3,4 and 5 only appear if this Screen is called from Screen 38 Map Mode as a DIRECT TO.

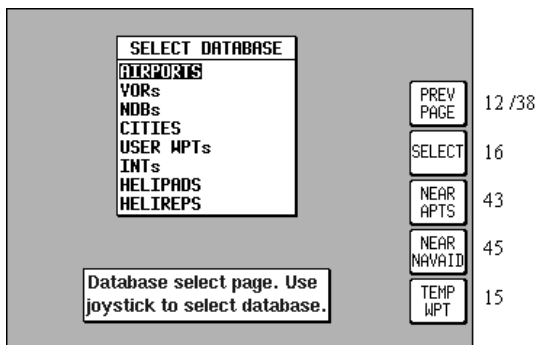

Screen 13: Database Selection Screen

When using an external GPS this screen can be accessed from screen 38, Key 5, DATABASE. If this screen is accessed this way, Key 5 changes to NEAR INTS. Pressing this key will display the ten nearest intersections.

By moving the cursor you select the database that contains the item you are looking for, whether to insert into your flight plan or to use as a DIRECT TO destination. Once you have the cursor over the correct database, touching Key 2, SELECT, will move you onto the next selection process, which is Screen 16 Item Selection.

As stated previously, Key 3, NEAR APTS and Key 4, NEAR NAVAID, only appear if this Screen has been entered after performing a DIRECT TO in Screen 38, Map Mode. For more information on the function of these keys, please refer to the Ten Nearest under the NAV Menu Screens Section in this manual.

As stated previously, Key 5, TEMP WPT, only appears if this Screen has been entered after performing a DIRECT TO in Screen 38, Map Mode. If you press Key 5, this will take you to Screen 15, which allows you to enter a DIRECT TO point.

Flight Planning Screens

If Key 1, PREV PAGE, is pressed to discontinue the selection process the unit will return to whichever the previous Screen was, either Screen 12, Flight Plan Program/Edit Screen, or Screen 38, Map Mode.

This Screen allows you to select a DIRECT TO specific latitude and longitude, and is reached by pressing Key 5 Temp Wpt on Screen 13.

Use the joystick to enter the latitude and longitude of the destination then press Key 2, ENTER, and Screen 47, Map Mode with Navigation Information, will appear with DIRECT TO OFF on Key 5.

INPUT DESTINATION		PREV PAGE 13
LAT: N3355.07		
LONG: W07805.00		
Temporary waypoint entry page. Use joystick to enter position.		
		ENTER 47

Screen 15: Temporary Waypoint Input Screen

SELECTING ITEM FROM CHOSEN DATABASE

On entry to this Screen you will find the cursor positioned over the first letter of the first item in the selected database.

If AIRPORTS, VORs, NDBs, INTs or AIRWAYS was selected on Screen 13, the first item in the data entry box on screen

16 is AREA:. This is an area filter that can be set to a specific ICAO country or area code. If set to EG for example, only items in British airspace will appear in the list. Similarly, if set to LF, only items in French airspace will be displayed. In the USA, the airspace is sub-divided into seven areas known as K1 - K7. The area filter can again be set to any of these areas (see Appendix 2 for a full list of country and area codes).

If the area filter is set to ALL, all the data from the selected database contained on the database card for the entire area covered will appear in the list.

SELECT AIRPORT		PREV PAGE 13
AREA: ALL		
ICAO: 10C		
NAME: GALT	/GREENWOODMONDE	
R/W: NONE		ENTER 12 /47
LAT: N4224.16		
LONG: W08822.55		
Item selection page. Use joystick to select item.		
		MORE INFO 44A/46A

Screen 16: Item Selection Screen

If AIRPORTS was selected on Screen 13 the cursor will be positioned over the word ICAO:. Airports may be selected by ICAO code, airport name or associated city name and in addition, once an airport has been selected, a particular runway threshold at that airport can be selected. If you wish to select an airport by name or associated city name, use the joystick to move the cursor down to name then right to the first character. If you wish to select a specific runway threshold, move the cursor down to R/W then right to the word NONE. Moving the joystick up or down will now allow you to select a specific runway threshold (if threshold information is available for that airport in the Jeppesen database).

When selecting names, use the joystick to scroll the initial letters through the alphabet. Once the required initial letter has been selected, move the joystick to the right and repeat the process. In this way you can scroll through all the items from the selected database, narrowing your search field. If you move the joystick to the left, the cursor will also move left one step, allowing you to make another selection.

If the airport name is followed by a number of ++++ signs, this indicates that there is more than one airport with the same name. To view the other airports with the same name, move the cursor over the ++++ signs then scroll up and down through the other airports with the same name using the joystick.

On this Screen, Key 5 labeled MORE INFO gives additional information about the selected item.

When an airport is selected but no runway, the entry into your flight plan will be the name displayed followed by the airport's ICAO code. When a runway is selected, the entry into your flight plan will be the airport's ICAO code followed by the runway ident. For example, if you select runway 22 at New Century AI, the entry to your flight plan would be KIXD 22.

Once you have reached the desired item, touching Key 2, ENTER, will select it and either return you to Screen 12, Flight Plan Program/Edit Screen, entering the item to your flight plan or invoke the DIRECT TO and take you to Screen 47, Map Mode with NAV Information, depending on which entry Flight Plan to Screen 13 you happen to have used. If the unit is set to receive external GPS/LORAN data, Key 2 changes to MAP, and if pressed returns to the Map screen.

If VORs, NDBs or intersections/approach waypoints were selected on Screen 13, Database Selection Screen, you will see a two letter ICAO area code displayed to the right of the identifier. If you have the area filter set to ALL, you can move the cursor over to the two letter ICAO code and select items with similar names in other areas.

NOTE:

When selecting a navaid, intersection or approach waypoint, check the ICAO area code carefully since there are many duplicates present in the database. Checking the area code will eliminate any ambiguity.

GRAPHICAL VIEWING AND EDITING OF FLIGHT PLANS

This Screen is accessed by pressing FLIGHT PLAN in Main Menu, followed by EDIT FPLN and Key 5, View Map, on Screen 11, Flight Plan Selection Screen. Screen 19 is displayed showing the starting point of the selected flight plan centered in the middle of the display. The legs and waypoints are shown as in this illustration.

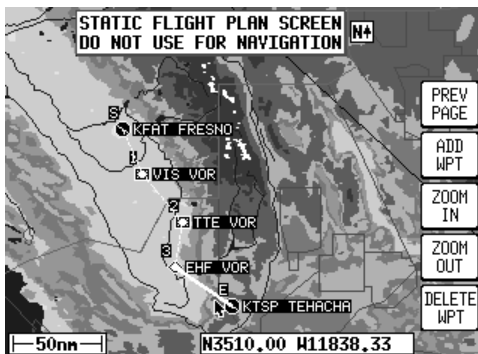

Screen 19: View and Edit Flight Plans On Map Screen

The joystick can be used to move the pointer. The screen window can be moved around the map by "bumping" the screen borders left, right, up or down with the pointer. This feature allows you to enter waypoints as a distance and bearing from the previous flight plan point.

To build a flight plan you simply point at the first item to be included in the flight plan and press Key 2, ADD WPT (or Add Waypoint). This will place an S (for Start) next to the waypoint. If no suitable data point or user waypoint is available beneath the pointer, a new user waypoint will be created; which can be name later by using Screen 9, Manual User Waypoint Edit Screen.

Then move the pointer to the second item (or first waypoint) in the flight plan and press Key 2, ADD WPT, again. This will place an E (for End) next to the waypoint. To systematically create additional legs, draw a line from the waypoint marked (E), with the pointer, to the next waypoint and press ADD WPT again. You will notice that the last point in the flight plan will always be labeled (E). Once you have finished building the flight plan press PREV PAGE, this will detach the pointer from the flight plan.

If you wish to add a new waypoint to a flight plan which you have stopped building (which is also the case if you are editing an existing flight plan), whether it is at the start, the end or the middle of the flight plan, you will need to highlight the appropriate point (i.e.: either the start waypoint (S), the end waypoint (E) or the leg line in which you

wish to add a new waypoint). As soon as you do this, the ADD WPT or GRAB LINE key will appear. Press the ADD WPT or GRAB LINE key to join the pointer back to the flight plan line and then move it to the new waypoint. Once over the new waypoint press ADD WPT.

If, for example you wanted to add a waypoint into the existing flight plan going from TTE VOR to EHF VOR shown in the previous illustration, you would first position the pointer over the track line between those waypoints, thereby highlighting it and then press Key 2, GRAB LINE. This will pick up the line. You would then move the pointer, stretching the track line like a rubber band, until it was over the waypoint that you wish to add and then press Key 2 ADD WPT. The new track line would then be set joining TTE VOR to the new waypoint to EHF VOR and the leg numbers shown next to the new waypoint and all subsequent waypoints would be increased by one. New waypoint would become 03, EHF VOR 04 and TEHACHAPI End.

If, for example you wanted to add a new waypoint to the beginning of the flight plan illustrated previously, simply move the pointer over FRESNO, thereby highlighting it and then press Key 2, ADD WPT. This will draw a line from the FRESNO to the pointer. Next move the pointer until it is over the new waypoint, highlight it and press Key 2, ADD WPT again. You may continue to add further waypoints from the new starting point by simply moving the pointer over another waypoint and pressing Key 2, ADD WPT. Press Key 1, PREV PAGE, to stop adding waypoints to the beginning of the flight plan.

To delete a Waypoint from a flight plan, point at the item you wish to remove and press Key 5, DELETE WPT. To delete a newly-created user waypoint, you have to return to Screen 9, Manual User Waypoint Edit Screen, or 10, View and Edit User waypoints on the Map Screen. You can create user waypoints on Screen 19 but not delete them from there.

NOTE:

It is important to remember that all changes made to a flight plan (either manually or graphically) are retained and that there is no undo option available. The only way to undo any changes made is to alter the flight plan back to its original state.

Intentionally left blank

MAP MODE SCREENS

Pressing MAP in Main Menu accesses this Screen. When you enter this Screen, if the KMD 150's internal GPS receiver has been able to establish a fix or if the external GPS you are using to feed your unit is sending valid data, a Screen similar to the one shown here will be displayed. The map is initially displayed at the Zoom Level where the Scale Bar

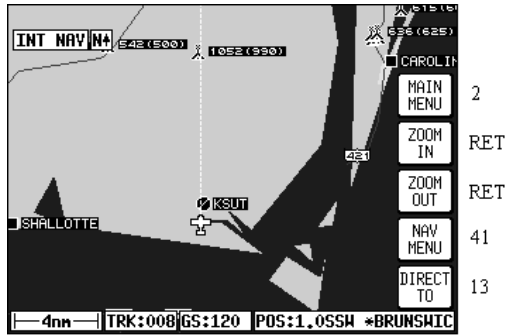

Joystick movement calls screen 39

Screen 38: Basic Map Mode Screen

represents 8nm. This is approximately the same scale as a 1:500,000 chart. If there is no valid GPS fix data available, the words NO FIX POSSIBLE will be shown across the center of the screen in a box. If the fix is lost at any time during normal operation of the unit, the same NO FIX POSSIBLE box will be overlaid on the map.

When an external GPS is in use, key 4 changes to MAP MENU, and key 5 changes to DATABASE. Both keys lead to the same screens as shown previously, but they have fewer options available (see applicable screens for details).

The map will be shown in either North Up mode or Track Up mode depending upon the setting you have made from Screen 22, Map Customization Screen.

NOTE:

When a map is displayed in North Up mode the  icon shall be displayed.

The displayed data will be updated every second. From this page, if you press Key 1, Screen 2 Main Menu will take its place. You can use Keys 2 and 3 at any time to zoom the map in and out to whichever one of the twelve pre-set scales you wish to use. The levels of detail appearing at each zoom level can be selected on Screen 22A/B or C, described in the Setup Screens Section of this manual. If you want to zoom in or out by more than one step at a time, you can apply multiple presses to Keys 2, ZOOM IN, and 3, ZOOM OUT, while watching the scale bar calibration figure.

The small boxes marked TRK: and GS: display your present track and ground speed. Ground speed is displayed in the units selected on Screen 22, Map Customization Screen. Track will be magnetic (i.e.: true with local variation automatically taken into account).

Map Mode Screens

The box marked POS: will display your present position as a distance and cardinal bearing from the nearest item in the database. The geographical item used to describe your position to you is chosen on the basis of the POSITION REF: setting on Screen 22, Map Customization Screen.

If you have chosen VORs as the position reference on Screen 22, your position will be reported as a distance (range) and bearing from the nearest VOR. If you have chosen VORs & AIRPORTS as the position reference on Screen 22 and your position is within 5nm of an airport, your position will be reported as a distance and bearing from that airport even if there is a VOR nearer (i.e. airports have priority). If there is no airport within 5nm then your position will be reported with respect to the nearest VOR or airport.

If you have chosen ALL DATA as the position reference on Screen 22 and your position is within 5nm of an airport, your position will be reported as a distance and bearing from that airport, even if there are nearer VORs, NDBs, towns, VRPs or waypoints. If there is no airport within 5nm then your position will be reported with respect to the nearest airport, VOR, NDB, VRP, town or waypoint.

All airport names are shown preceded by an asterisk character (*) in order to distinguish them from towns or cities with similar names, which may have significantly different locations.

At the bottom left hand corner of the display you will also see a Scale Bar showing a measurement. The measurement may be in nautical miles, statute miles or kilometers depending on the map units, which you have selected from Screen 22. Map Customization Screen.

Pressing Key 4 will take you to Screen 41, the NAV Menu Cover Screen (or MAP Menu Cover Screen if external GPS). Pressing Key 5 will take you to Screen 13 from which you can select a DIRECT TO destination (if internal GPS).

Under normal circumstances, you will not see any joystick pointer on Screen 38. However, if you do move the joystick, a pointer will appear just beside your present position icon and the display will change to Screen 39.

DATA INTERROGATION AND GRAPHICAL DIRECT TO

As soon as you move the joystick while in Screen 38, Map Mode, a Screen similar to Screen 39 will be displayed. The map freezes in its present position with respect to the joystick pointer and the aircraft symbol indicating your present position starts to move across the Screen. A line appears between present position and the joystick pointer. (The reason the map is made to stop moving is that this makes accurate positioning of the joystick pointer much easier for you.)

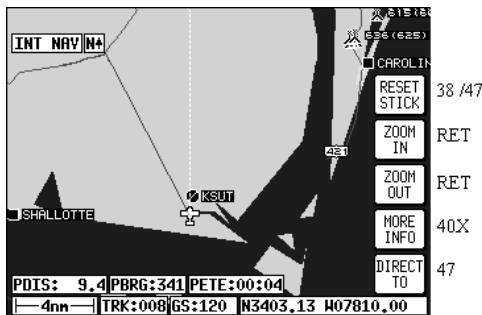

This screen times-out back to previous screen if joystick not moved or a key is not hit for 30 seconds

Screen 39: Map Mode with Joystick Active Screen

Simultaneously, you will see the TRK and GS boxes have now changed to DIS, BRG and PETE (Pointer ETE). These now show the distance and bearing **from** present position **to** the joystick pointer and the pointer estimated time enroute (PETE). The PETE is calculated on present GS and would read 00:00 if you were stationary. You can use this function to measure distance, bearing and estimated time enroute to any point on the map. The window formed by the extremities of the Screen can be moved around the map by "bumping" the Screen borders left, right, up or down with the pointer. You can still use Keys 2, ZOOM IN, and 3, ZOOM OUT, to zoom the map in and out. When you are finished using this Screen press Key 1, RESET STICK, and the joystick pointer will vanish, your display will return to Screen 38 and the map will be placed back in its present position at the zoom level it was at prior to activating the joystick. If you don't move the joystick for 30 seconds, this will have the same effect as pressing Key 1.

In addition to finding it useful for measuring distances, bearings and ETES, you can utilize this Screen for other tasks. If you place the pointer over any data icon and then press Key 4, MORE INFO, Screen 40 (Airport), Screen 40A (Navaid) or Screen 40C (all other data icons) will appear. These Screens contain additional data and information on the selected item.

If you want to navigate directly to any position, press Key 5 and you will obtain a DIRECT TO, taking you to wherever the pointer is positioned, even if it is not pointing to a database item. This is a very useful feature for arbitrary in-flight diversions. After you have pressed Key 5, DIRECT TO, Screen 47, Map Mode with NAV Info, appears, with Key 5 now labeled "DIRECT TO OFF".

AIRPORT INFORMATION

As explained previously, you can access this Screen from Screen 39 by placing the joystick pointer over an airport icon and pressing Key 4, MORE INFO. All the information given here is derived from the built-in Jeppesen database. Runway surfaces are shown as an H for hard and an S for soft. Lighting is shown as an L for lit and a U for unlit.

This screen times-out back to previous screen after 30 seconds.

Screen 40: Map Mode Airport Info Screen

To obtain DIRECT TO for the chosen airport all you have to do is press Key 5, labeled DIRECT TO. To return to the Map of Screen 39 you should press Key 1, PREV PAGE. Alternatively, the unit gives you 30 seconds to read what you require from the Info Screen and then automatically returns to Screen 39.

Pressing Key 5, DIRECT TO, in Map Mode when the joystick is not active, can also access this Screen. Allowing you to call up the item of interest from the airports database as if you were selecting it for a DIRECT TO. If this Screen were entered this way Key 4, VIEW AREA, would be present allowing you to not only view the appropriate airport data but also look at its position on the map.

NAVAID INFORMATION

As explained previously, you can access this Screen from Screen 39 by placing the joystick pointer over a VOR or NDB icon and pressing Key 4, MORE INFO. Full details of the Navaid are listed, type, frequency and ident. The fourth line in the box is a visual representation of the Morse ident and if you are one of those pilots whose knowledge of Morse is less than perfect, all you have to do

this screen times-out back to the previous screen if joystick not moved or key is not hit for 30 seconds.

Screen 40A: Map Mode Navaid Information Screen

do is press Key 2, IDENT. The unit will beep out the correct ident (on its internal speaker and on the external alarm, if this is switched on). You can then compare this to the ident you are hearing over the radio to verify that you are indeed tuned to the navaid you want.

To obtain DIRECT TO for the chosen Navaid (VOR or NDB) all you have to do is press Key 5, labeled DIRECT TO. To return to the Map of Screen 39 you should press Key 1, PREV PAGE. Alternatively, the unit gives you 30 seconds to read what you require and then automatically returns to Screen 39.

Pressing Key 5, DIRECT TO, in Map Mode when the joystick is not active, can also access this Screen. Allowing you to call up the item of interest from the either the VORs or NDBs database as if you were selecting it for a DIRECT TO. If this Screen were entered this way Key 4, VIEW AREA, would be present allowing you to not only view the appropriate navaid data but also look at its position on the map.

GENERAL ICON INFORMATION

As explained previously, you can access this Screen from Screen 39 by placing the joystick pointer over any data icon that is not an airport, VOR or NDB and pressing Key 4, MORE INFO. All available information concerning the chosen data item is then listed.

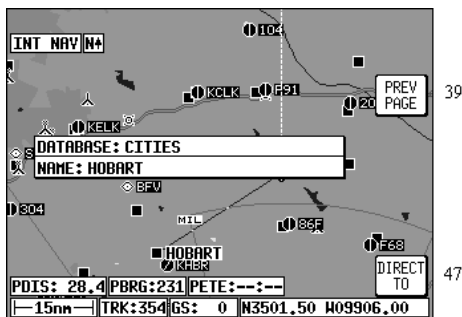

This screen times-out back to previous screen if joystick is not moved or key is not hit for 30 seconds.

Screen 40C: Map Mode General Information Screen

To obtain DIRECT TO for the chosen item all you have to do is press Key 5, labeled DIRECT TO. To return to the Map of Screen 39 you should press Key 1, PREV PAGE. Alternatively, the unit gives you 30 seconds to read what you require and then automatically returns to Screen 39.

AIRSPACE INTERROGATION

In order to interrogate a piece of airspace in Map Mode, move the joystick operated pointer and point at one of the airspace boundaries. After you have released the joystick, the software will search the airspace database and after a short time will re-draw the piece of airspace to which you have pointed in a bolder line with a basic information tag attached.

IMPORTANT:

When a single airspace boundary line is shared by two different pieces of airspace (which is very common), the airspace with the lower vertical limit will always be highlighted.

Once you are sure the piece of airspace highlighted is the piece you want information on (you may have to zoom out to verify this, but beware, some airspace switches off as you zoom out dependent on the settings made in Screen 22C, Airspace Data Class Setup Screen), press MORE INFO key and Screen 40B, Airspace Information Screen, will be displayed.

The information shown on this screen is all the information from the internal Jeppesen database that is relevant to the airspace you have selected. If some of the fields are blank or say SEE CHART, this means that Jeppesen data is not available for that particular item.

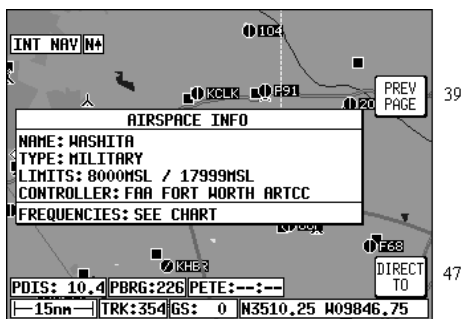

This screen times-out back to previous screen if joystick is not moved or key is not hit for 30 seconds.

Screen 40B: Airspace Information Screen

NAV MENU SCREENS

You can enter this important Screen by pressing Key 4, NAV MENU (or MAP MENU if set to External GPS), while in Map Mode (on Screen 38 or 47). It is a versatile Screen with several useful functions.

When Terrain data is available, a map key shall be displayed indicating the colors used for different terrain heights.

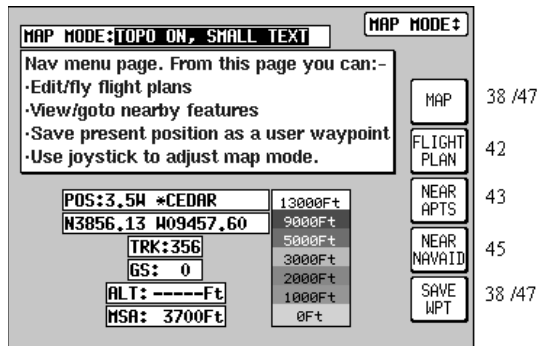

Screen 41: NAV Menu Cover Screen

When an external GPS is in use, Key 2 has no function and key 5 changes to NEAR INTS. Pressing key 5 will display the ten nearest intersections.

If you move the joystick up or down when in this Screen, the screen layout presented when displaying the Map can be selected to be one of the following. The setting is indicated in the box at the top of the screen labeled MAP MODE:.

TOPO ON, SMALL TEXT: Large map, full color cartography, and small NAV information text.

CDI (TOPO ON): Pseudo CDI style display, which reverts to Topo Small Text map when joystick is hit (not available in External GPS mode).

TOPO ON, LARGE TXT: Large map, full color cartography, and large NAV information text. This will revert to the Topo Small Text map when the joystick is hit (not available in External GPS mode).

TOPO OFF, SMALL TEXT: Large map, black background, no cartography, Jeppesen data only, small NAV information text.

CDI (TOPO OFF): Pseudo CDI style display, which reverts to non Topo Small Text map when joystick is hit (not available in External GPS mode).

TOPO OFF, LARGE TXT: Large map, black background, no cartography, Jeppesen data only, large NAV information text. This will revert to the non Topo Small Text map when the joystick is hit (not available in External GPS mode).

NOTE:

Large Text and CDI modes are only active when a DIRECT TO or flight plan is running.

Nav Menu Screens

Please refer to the Map Setup Screens in the Setup Screens Section of this manual for further information regarding data settings for each mode.

If you wish to return to the Map Screen at any time, press Key 1, MAP.

Key 2, FLIGHT PLAN, gives you direct access to Flight Planning Mode where you can manually select, cancel and edit Flight Plans as required.

If you press Key 3, NEAR APTS, you will be presented with Screen 43, Ten Nearest Airports Screen, on which you can read off the ten airports nearest to your present position.

If you press Key 4, NEAR NAVAID, you will see Screen 45, Ten Nearest Nav aids Screen, giving you details of the ten VORs and NDBs nearest to you. For more information on Screens 43 and 45 refer to the Ten Nearest later on in this section of the manual.

If you wish to save your present position, press Key 5, SAVE WPT, and your co-ordinates will be saved as the next available user waypoint number. Once the user waypoint has been saved, the Screen will revert to Map Mode (Screen 38 or 47) where the new user waypoint will already feature on the map. This feature is not available when set to External GPS mode.

The text boxes on this screen give the following information:

Map Mode selected (one of six options described previously)

Position in plain English

Position in latitude/longitude (or the co-ordinate system selected on the Map Setup Screen)

Track and Ground Speed

GPS Altitude

MSA for the present position

The MSA box displays the highest Grid MORA value within a ten mile radius of your present position at all times. See Appendix 2 for a more detailed explanation of Grid MORA.

WARNING:

The MSA altitudes displayed are advisory in nature only. They should not be relied upon as the sole source of obstacle and terrain avoidance information. Always refer to current aeronautical charts for appropriate minimum clearance altitudes.

SELECTING A FLIGHT PLAN

Pressing Key 2, FLIGHT PLAN, on Screen 41, NAV Menu Cover Screen, enters this Screen. On entry to this Screen you will see a cursor positioned over the Number of the last flight plan accessed, or if there is a flight plan already active, its number will be shown instead. You will see the first few items of the selected flight plan

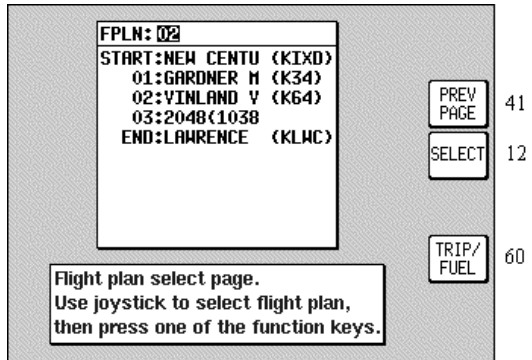

Screen 42: Flight Plan Selection Screen

together with its final destination in the box under the Flight Plan Number. You can select any flight plan you want by using the joystick to scroll the flight plan number up or down. You are free to select any one of the 99 available flight plans. If you wish to return to the NAV Menu Cover Screen (Screen 41) press the PREV PAGE Key 1. Pressing Key 2 will call Screen 12, Flight Plan Program/Edit Screen for the selected flight plan.

If the selected flight plan is already running, Key 5 will read FPLN OFF, and Key 2 will be blank. If the selected flight plan is not active, Key 5 will be blank and Key 1 will read SELECT. An active flight plan can be switched off at any time by pressing Key 5, FPLN OFF.

Pressing Key 5 will cancel the active flight plan and allow you to gain access to what was the active flight plan. (In the interests of safety, the software has been designed not to permit you to edit and fly a flight plan at the same time.)

Pressing Key 4 gives a shortcut to Screen 60, the E6-B Trip/Fuel Planning Screen (see Trip/Fuel Planning in the E6B Calculator Section of this manual for more detail). When Screen 60 is displayed the flight plan selected on Screen 42 will automatically be shown.

In order to select a flight plan to fly, bring up the desired Flight Plan Number with the joystick and press Key 1, SELECT, in Screen 42, Flight Plan Selection Screen. This will call Screen 12 from which you can choose to edit the flight plan, reverse the flight plan or activate the flight plan. In order to activate the flight plan, simply use the joystick to select the desired leg then press Key 5, FLY FPLN. If you have highlighted a leg other than Start or 01 you will be prompted with the following message, "Do you want to fly the first leg of the flight plan or the currently selected leg?" Three possible responses are available, Key 1, ABORT will cancel the fly flight plan action, key 3 FIST LEG to fly from the first leg, or key 5 SEL'D LEG to fly from the highlighted leg.

FPLN: 01	REF	
START:NEW CENTU (KIXD)	IA	
01:OSW VOR	IV	
02:VINITA MU (H04)	IA	
03:CLAREMORE	IT	
04:HENRYETTA	IT	
05:15 30(500)	OB	
06:DENISON	IA	
07:DALLAS (KADS)	IA	

LEG: 101nn FPLN: 966nn

LEG MSA: 3300Ft FPLN MSA: 16800Ft

Flight plan edit page. Use joystick to select a leg, then press one of the function keys.

PREV PAGE 11 /42

INSERT ITEM 13

DELETE ITEM RET

INVERT FPLN RET

FLY FPLN 47

Screen 12: Flight Plan Program/Edit Screen

press Key 5, FLY FPLN. If you have highlighted a leg other than Start or 01 you will be prompted with the following message, "Do you want to fly the first leg of the flight plan or the currently selected leg?" Three possible responses are available, Key 1, ABORT will cancel the fly flight plan action, key 3 FIST LEG to fly from the first leg, or key 5 SEL'D LEG to fly from the highlighted leg.

NOTE:

If you have activated AUTO LEG SELECT on Screen 23, NAV Mode Customization Screen, the nearest leg to your present position will automatically be selected for you as soon as you enter Screen 12.

TEN NEAREST AIRPORTS

This Screen is accessed by pressing Key 3, NEAR APTS, on Screen 41, NAV Menu Cover Screen, and dynamically shows the range and bearing of the ten nearest airports. When this Screen appears you will find a cursor over the first airport in the list.

NAME	BRG	DIS
CEDAR (513)	089	3.5
NEW CENTU (KIXD)	148	7.0
GARDNER M (K34)	174	7.7
JOHNSON C (K0JC)	112	11
VINLAND V (K64)	236	11
LAWRENCE (KLWC)	286	12
HILLSIDE (63K)	108	17

Nearest airport page. Use the joystick to select an airport.

POS: 3.5W *CEDAR

TRK: 356 GS: 0 ALT: -----Ft

MAP 38 /47

PREV PAGE 41

MORE INFO 44

NEAR NAVALD 45

DIRECT TO 47

Screen 43: Ten Nearest Airports Screen

You can scroll up and down the list by using the joystick. Once the cursor is lying over the name of the airport you require, if you press Key 3, MORE INFO, Screen 44 will appear, giving you additional information about that airport.

To obtain a DIRECT TO for the chosen airport all you have to do is press Key 5, labeled DIRECT TO, and you will switch back to (Screen 47) Map Mode with the selected DIRECT TO activated.

Key 1, MAP, returns you to Map Mode ,Screen 38 or 47. Key 2 returns you to the NAV Menu Cover Screen (Screen 41). By pressing Key 4, NEAR NAVAID, you can switch to Screen 45, Ten Nearest Navaid's, giving information about the ten nearest navaid's.

Once you have selected an airport on Screen 43 and pressed Key 3, MORE INFO, the display will change to Screen 44. This gives additional information about runways, frequencies, elevation etc. for the airport in question.

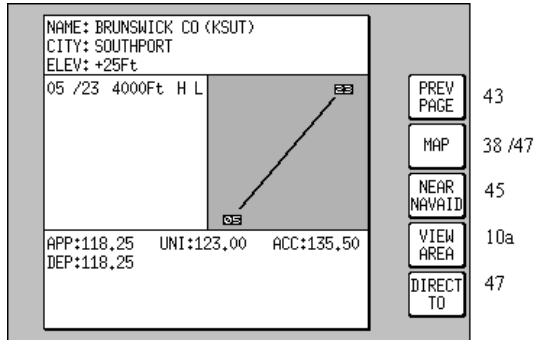

Screen 44: Airport Information Screen

To return from this Screen to Map Mode (Screen 38 or 47) you simply press Key 2. To select another airport from the Ten Nearest (Screen 43) you press Key 1 and if you want to see the list of ten nearest navaid's, simply press Key 4, which will take you directly to Screen 45, Ten Nearest Navaid's. To obtain a DIRECT TO for the chosen airport all you have to do is press Key 5, labeled DIRECT TO, and you will switch back to (Screen 47) Map Mode with the selected DIRECT TO activated.

If you want to view the area immediately around the chosen airport, press Key 3. This will call Screen 10A that is very similar to Screen 10, the View and Edit User Waypoint on the Map Screen. Screen 10A will revert back to screen 44 after 30 seconds with no key or joystick activity or can be cancelled by pressing Key 1, PREV PAGE.

NAVAIDS

This Screen is accessed by pressing Key 4, NEAR NAVAID, on Screen 41, NAV Menu Cover Screen, and dynamically shows the range and bearing of the ten nearest nav aids. When this Screen appears you will find a cursor placed over the first navaid in the list. The list can be scrolled up and down using the joystick. Once you have placed the cursor over the name of the navaid you want, press Key 3, MORE INFO, to display Screen 46, which gives additional information about that navaid.

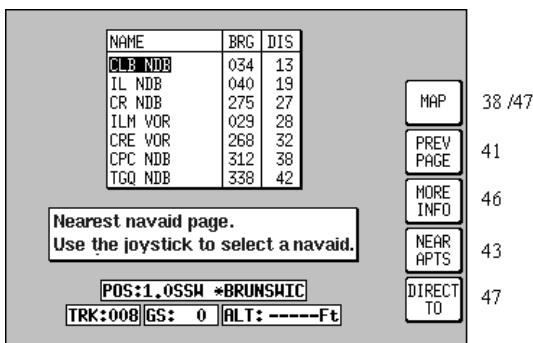

Screen 45: Ten Nearest Nav aids Screen

Pressing Key 1 will return you to Map Mode (Screen 38 or 47). Key 2 returns you to Screen 41, NAV Menu Cover Screen. Pressing Key 4, NEAR APTS, will take you to Screen 43, giving you the list of the ten nearest airports.

To obtain a DIRECT TO for the chosen navaid all you have to do is press Key 5, labeled DIRECT TO, and you will switch back to (Screen 47) Map Mode with the selected DIRECT TO activated.

The Screen shown here shows the additional information about the navaid chosen on Screen 45, Ten Nearest Nav aids.

From here by pressing Key 2 you will get back to Map Mode (Screen 38 or 47). To select another navaid from the Ten Nearest (Screen 45) you press Key 1. If you press Key 3, IDENT, the unit will mimic the Morse Code ident for the chosen navaid on the internal speaker (and on the external alarm if you switched this on in Screen 23, NAV Mode Customization Screen).

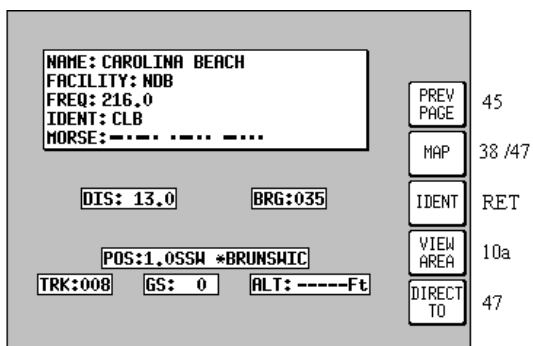

Screen 46: Nav aid Information Screen

If you want to view the area immediately around the chosen navaid, press Key 4. This will call Screen 10A that is very similar to screen 10, the View and Edit User Waypoint on the Map Screen. Screen 10A will revert back to screen 46 after 30 seconds with no key or joystick activity or can be cancelled by pressing Key 1, PREV PAGE.

To obtain a DIRECT TO for the chosen navaid all you have to do is press Key 4, labeled DIRECT TO, and you will switch back to (Screen 47) Map Mode with the selected DIRECT TO activated.

Intentionally left blank

MAP MODE WITH NAV INFORMATION

This section applies to Internal GPS mode only. Whenever a Flight Plan is active or you have called for a DIRECT TO, the map will have extra navigation information added to it and will resemble Screen 47. Alternatively you may have selected one of the other NAV Modes detailed in the NAV Menu Screens Section of this manual. The same navigation data is presented on all the

alternative screens in different ways. The following text refers to the standard NAV Mode Screen setting (TOPO ON, SMALL TEXT). Alternative Screens 47A and 47B are discussed at the end of this section.

If the TOPO OFF, SMALL TEXT mode is selected, the map will display aeronautical data only on a black background.

The Course Deviation Indicator (CDI) at the bottom right of the map can be switched ON or OFF or be set to work numerically and the Full Scale Deflection (FSD) selected on Screen 23, NAV Mode Customization Screen. If you have selected the CDI alarm ON, when the last element of the CDI bar graph comes on (or when the full scale value as set on Screen 23 is reached) the internal and external alarms (if switched on) will beep at a rate of 2Hz for 5 seconds.

Key 5 will change to ALARM OFF and if you press this before the 5 seconds are up this will silence the alarm. When the alarm switches off automatically after 5 seconds, Key 5's label will go blank and have no function for 2 seconds then revert to DIRECT TO (or DIRECT TO OFF). This is to make sure you don't inadvertently select or cancel DIRECT TO mode if you press this key just as it is canceling automatically. The CDI alarm resets itself as soon as you come back within the full scale set. It will then be reactivated whenever the full scale is exceeded again.

The box at the bottom left of the map window shows the destination point when you are in DIRECT TO Mode preceded by the "DIRECT TO" symbol or the FROM and TO waypoints when you are in Flight Plan Mode. If the destination point has no name the text TEMP WPT will be shown.

A great deal of other navigation information is available to you above and below the map. Starting at the top of the screen on the left hand side you

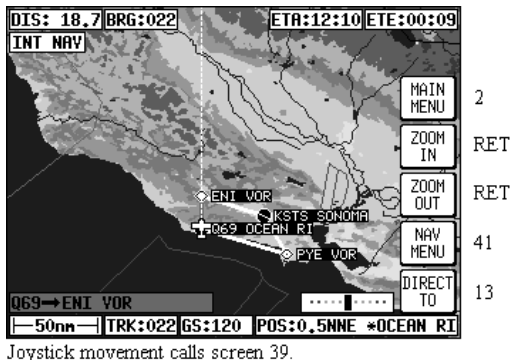

Screen 47: Map Mode with NAV Information Screen

Map Mode with Nav Information

will see DIS. This is the distance or range to run to the destination point from your present position. This distance figure is given in whichever units you selected on Screen 22, Map Customization Screen. In the left center of the screen at the top you can read BRG. This is the magnetic heading to steer (assuming no wind) to the next waypoint.

To the right of BRG at the top of the map is the ETE. This gives the Estimated Time Enroute (i.e. the estimated time in hours and minutes) that it will take you to get to the destination point from your present position assuming you maintain your present ground speed.

On the KMD 150 unit only, at the top right of the map is the ETA. This is the Estimated Time of Arrival at the next waypoint. **Ensure you have set the local time offset correctly to get correct ETA's.** Refer to the GPS Status Screens Section of this manual for more details. (The reason that ETA is not available when in External GPS mode is that, depending on the type of GPS receiver in use, real time and local time offset is not always known.)

In the left center of the screen at the bottom is TRK. This is the actual magnetic track the aircraft is traveling over the ground. By comparing this with your magnetic heading you can make an estimate of the cross-wind component.

To the right of TRK is GS. This is the actual ground speed of the aircraft and is displayed in Knots if you set the map units to nautical miles on Screen 22, Map Customization Screen, MPH if you set them to statute miles or KPH if the map units are set to kilometers. By comparing the GS with your TAS you can make an estimate of the head or tail wind component. Alternatively refer to Screen 58, Density Altitude, True Air Speed, and Winds Aloft Screen in the E6B Calculator Screens Section of this manual.

If ground speed is less than 3 Kt., the map will revert to North Up even if Track Up is selected. This is to stop the map rotating when static due to the effects of SA (Selective Availability, see Appendix 3 for further details of SA).

If you have entered this Screen 47 by activating a flight plan, a DIRECT TO can be performed on top of the flight plan. You can initiate the DIRECT TO either to a point within the current active flight plan, an item from the database, by using the joystick pointer or by calling up one of the 10 nearest airports or nav aids. In each case Key 5's label will change to "DIRECT TO OFF". The flight plan that was previously active will fall into the background and will be replaced by the DIRECT TO information. When the DIRECT TO destination is reached or whenever you press the DIRECT TO OFF Key (Key 5), the flight plan and its information will be reinstated.

VIEWING ENROUTE ETA'S, PERFORMING A DIRECT-TO ON TOP OF FLIGHT PLAN

When flying a flight plan, the ETA's for each leg of the flight plan can be viewed on Screen 41A which is accessed by pressing Key 5 (DIRECT TO) on the MAP screen (screen 41) provided the joystick is not active.

FPLN: 02	ETA	SEL WPT+
START:NEW CENTU (KIXD)	12:01:53	MAP
01:GARDNER H (K34)	12:02:22	
02:VINLAND V (K64)	12:52:11	
03:2048(1038)	13:08:26	
END:LAWRENCE (KLWC)	13:22:51	

ETAs / Direct-To page.
Use joystick to scroll through flight plan.

DATA BASE

Screen 41A: View ETA's and Skip Leg Screen

PERFORMING A DIRECT-TO ON TOP OF A FLIGHT PLAN

The Direct-To function allows you to perform a short cut while flying a flight plan by skipping over intermediate legs and flying directly to a point further along your flight plan. Once the selected point is reached, the normal flight plan is automatically resumed.

On the ETA's Screen (Screen 41A), Key 3 is labeled DIRECT TO. The cursor bar, which is highlighting the current destination waypoint, can be moved up and down the active flight plan with the joystick.

If a waypoint further down the flight plan is selected then the DIRECT TO key is hit, the unit will return to the map with a pseudo DIRECT TO running on top of the flight plan to the selected point. The CDI will be centered and the FROM-TO box will be replaced with a 'direct to' box. Once the selected point is reached, the normal flight plan is automatically resumed.

This function is very useful if you have been forced off your flight plan and wish to take the flight plan up again at a later waypoint.

PERFORMING A DIRECT TO A POINT NOT IN THE ACTIVE FLIGHT PLAN

Key 5, labeled DATABASE gives access to the entire database from which any point can be chosen to fly directly to. If you have a flight plan running and you use this process to fly directly to an unrelated destination, when that destination is reached or if the DIRECT TO is cancelled, the original flight plan will be resumed at its nearest point.

ARRIVAL AT AN ENROUTE WAYPOINT

To set the radius for the Arrival Alarm you should refer to the data on Screen 23, NAV Mode Customization Screen. When the distance remaining to run to an enroute waypoint falls below the Arrival Alarm value, the [WPT ALERT] flag is displayed and the internal and external alarms (if switched on) beep at a rate of 2Hz for 5 seconds. To make the change to NEXT LEG you have to press Key 1 and if you wish to silence the alarm before the 5 seconds are up, simply press Key 5, the label of which has meantime changed to ALARM OFF. When the alarm is switched off automatically after 5 seconds, Key 5 will go blank and have no function for 2 seconds then revert to DIRECT TO. This is a safety measure to prevent you from inadvertently selecting DIRECT TO mode by pressing the key just as it is canceling automatically.

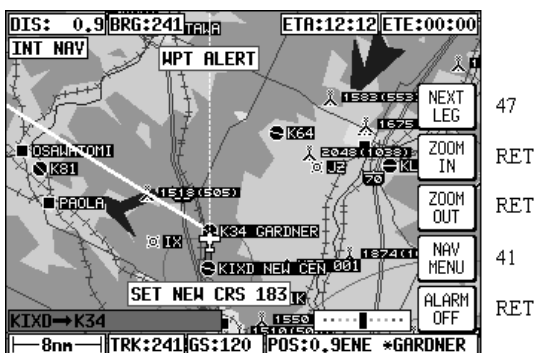

Joystick movement calls screen 39.

Screen 48: NAV Information and WPT IMMINENT Flags Showing - Enroute Screen

Once you have pressed Key 1 to select the next leg, Screen 47 reappears showing all the relevant information for the new leg. The next leg of the flight plan will now be displayed as a solid line.

If you pass the WPT, the flag will change to [WPT PASSED]. If the unit has been set up for AUTO NEXT LEG in Screen 23, then as the WPT is passed the unit will automatically revert to Screen 47 with all the new leg information. Key 1 will go blank and inactive for two seconds then revert to MAIN MENU.

When the WPT ALERT alarm has been given, a new box will appear at the bottom of the screen showing the new course [SET NEW CRS XXX] to steer for the next leg of the flight plan. The next leg of the flight plan will also be displayed as a dotted line.

Prior to reaching a waypoint within a flight plan, Turn Anticipation provides navigation along a curved path segment to ensure a smooth transition between two adjacent legs in the flight plan. The curved path segment is based upon the aircraft's ground speed and the amount of course angle change between the legs.

Turn Anticipation will only work if it is selected ON in Screen 23, NAV Mode Customization Screen, and if the course change is greater than 5°

and less than 90°. If the course change is less than 5° then turn anticipation is not necessary. If the course change is greater than 90° it is up to the pilot which way round the waypoint he turns.

If Turn Anticipation is set to ON and the upcoming leg satisfies the Turn Anticipation rules (i.e. course change >5° or <90°), the Turn Anticipation function is activated. If Turn Anticipation is switched OFF or the upcoming leg course change is >90°, you may get a STEEP TURN warning. The Steep Turn warning will be given if the upcoming turn will involve a bank angle in excess of 25° based on current ground speed.

ARRIVAL AT YOUR FINAL DESTINATION

This Screen appears whenever the next waypoint is the last in the current flight plan. When the distance to run to the last WPT falls below the Arrival Alarm value, the [WPT ALERT] flag is shown and the internal and external alarms (if switched on) beep at a rate of 2Hz for 5 seconds.

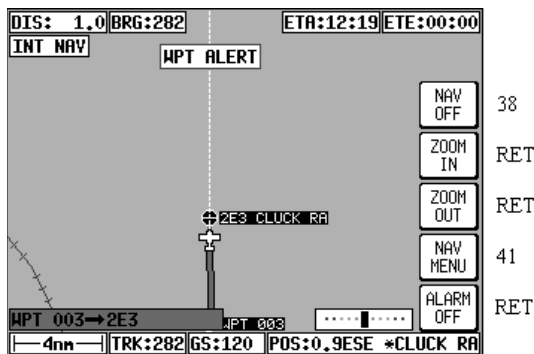

Joystick movement calls screen 39.

The label for Key 1 changes to NAV OFF and that for Key 5 changes to ALARM OFF. If you press Key 5 the audible alarm is silenced. The alarm will switch itself off automatically after 5 seconds, then after a further 2 seconds the label for Key 5 will revert to DIRECT TO (or DIRECT TO OFF if in DIRECT TO mode).

Screen 49: NAV Information and WPT ALERT Flags Showing - Final Screen

If you are in Flight Plan Mode when Key 1 is pressed, NAV Mode is cancelled and Screen 38 is called. If you are in DIRECT TO mode when Key 5 is pressed, DIRECT TO Mode is cancelled and Screen 38 will appear. If you are in DIRECT TO Mode with an underlying flight plan still active when you press Key 5, DIRECT TO Mode will be cancelled and Screen 47 will reappear with the original flight plan reinstated.

As the last WPT is passed, the flag will change to [WPT PASSED].

ALTERNATIVE MAP MODES

You may have selected one of the other Map Modes detailed in the NAV Menu Screens Section of this manual. The same navigation data as described previously is presented on all the alternative screens in different ways.

LARGE TEXT MODE

When the KMD 150 in the Internal Navigation Mode, this Screen presents the numeric navigation information in large text laid over the map display in such a way as to allow you a forward view of the map if being used in Track Up Mode. As with standard Map Mode, the CDI scale and format may be adjusted. If the joystick is touched, the display will immediately revert to

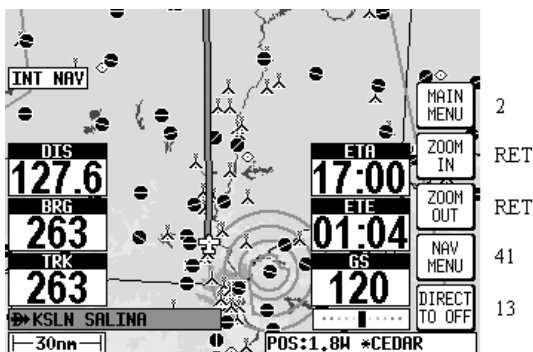

Joystick movement calls screen 39.

Screen 47A: Topo On Large Text NAV Information Screen

Topo On, Small Text format to allow full use of map graphics. When the joystick is reset or after 30 seconds with no key or joystick activity, Screen 47A will be reinstated. If the unit is External Navigation Mode, this Screen is not available.

As Topo On, Small Text Map Mode, if the Topo Off Mode is selected, the map will display aeronautical data only on a black background.

CDI MODE

When the KMD 150 in the Internal Navigation Mode, this Screen presents numeric navigation information in small text but instead of a map display, shows a pseudo CDI complete with OBS knob. The aircraft icon in the center of the CDI will remain static and the outer ring represents the



Screen 47B: Large Text & CDI (Pseudo HSI) NAV Information Screen

desired magnetic track between the start waypoint and the destination waypoint (i.e. magnetic bearing to waypoint if you were on track). On entering NAV Mode or activating a new flight plan leg or a DIRECT TO, the outer ring will show the desired track to the active waypoint.

A GPS TRACK bug that rotates with the aircraft's actual track, is positioned on the CDI outer ring. This indicates the actual magnetic track of the aircraft. There is also included a conventional TO / FROM flag.

Flying with the pseudo CDI is very similar to flying with a conventional VOR indicator. Off track error (XTE) is represented by a bar that moves left or right of center. The center of the scale represents the aircraft's position. As with a conventional CDI or VOR indicator, to correct your track error, fly towards the bar. The full scale deflection or scale of the CDI can be selected on Screen 23, NAV Mode Customization Screen.

In order to gain, and remain on the desired track, adjust your aircraft heading until the CDI bar is centered. Once the CDI bar is in the center of the display indicating no cross track error (XTE), adjust your aircraft heading in small increments until the track bug, which rotates around the outer ring, is at the top of the display.

Once the CDI is centered and the track bug is aligned at the top of the display you are flying precisely along your desired track. If the track bug is aligned at the top of the display but the CDI bar is not centered, this indicates you are flying parallel to your desired track by however far the XTE is indicating.

The TO / FROM flag will normally point up to indicate you are flying TO the waypoint. When you pass your destination waypoint, the TO / FROM flag will point down to indicate you have passed the waypoint and you are now flying away FROM your destination. As you pass your waypoint and the FROM flag appears, the desired track ring will remain fixed at the original desired track and the CDI will continue to show track error left or right of the extended leg line.

If, while enroute to a destination you decide that you would like to approach that destination point from an angle other than that displayed on the CDI by the desired track ring, you can alter the desired track setting by pushing the INC OBS (increment OBS) or DEC OBS (decrement OBS) Keys. This feature is not available in EXT GPS mode.

This has the effect of rotating your desired track ring and hence rotating the desired track line on the map screen using the destination point as a pivot. For example if you were approaching an airport from the south west on an inbound heading of 070° but the runway in use at that airport was 09, it may be desirable to approach the airport on a heading of 090° so that you were lined up for the approach.

By pressing the INC OBS Key you would increment the desired track setting from 070° to 090°. The CDI would then show a fly left indication because you would be off track to the right from your new track line. By

Map Mode with Nav Information

turning left it would then be possible to intercept the new track line then fly straight into the airport on the new approach heading.

If the joystick is touched, the display will immediately revert to Large Map format to allow full use of map graphics. When the joystick is reset, Screen 47B will be reinstated. When flying with the CDI selected, WPT ALERT messages and other warnings will be displayed in the CDI area. If the unit is External Navigation Mode, this Screen is not available.

E6-B CALCULATOR

E6-B functions are accessible by pressing Key 3, NOTE PAD, in Main Menu followed by Key 3, E6-B CALC, in the Note Pad Screen. This gives access to Screen 57, E6-B Calculator Screen. This function is not available in Demo Mode.

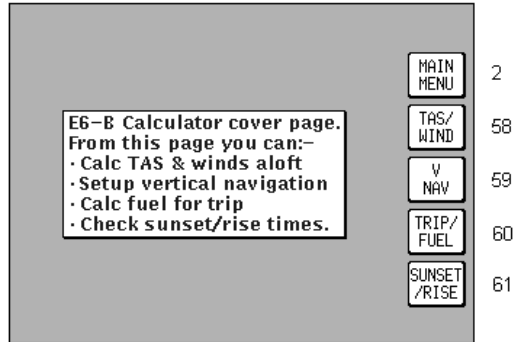

Screen 57: E6-B Calculator Cover Screen

Key 1 returns you to Screen 2 Main Menu.

Key 2 calls Screen 58, the Density Altitude/TAS/Winds Aloft Calculator page.

Key 3 calls Screen 59, Vertical Navigation page.

Key 4 calls Screen 60, Trip/Fuel Planning page.

Key 5 calls Screen 61, Sunset/Sunrise Calculator page.

DENSITY ALTITUDE/TAS/WINDS ALOFT CALCULATOR

On entry to this Screen a cursor will be positioned over the Indicated Altitude (IALT) data entry field.

TO CALCULATE DENSITY ALTITUDE (DALT) AND TRUE AIRSPEED (TAS)

1. Enter the altitude reading from your altimeter next to the IALT heading. Default value on entry to Screen is internal GPS altitude for KMD 150 or 2000 if in External GPS mode.

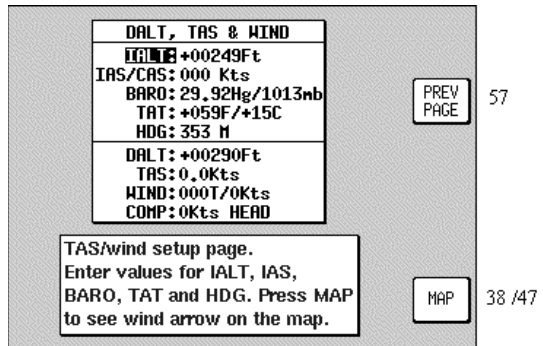

Screen 58: Density Altitude, True Air Speed & Winds Aloft Screen

2. Move the cursor over the entry field next to the heading IAS/CAS and enter your indicated or calibrated airspeed. Default value on entry to this Screen is GPS ground speed.

E6-B Calculator

3. Move the cursor over the entry field next to the heading PRESS and enter the atmospheric pressure in either inches of mercury (Hg) or millibars (mb). Default value is 29.92Hg / 1013mb.

4. Move the cursor over the entry field next to the heading TAT and enter the total air temperature read from your external aircraft thermometer in either F or C. Default value on entry to this Screen is 59F/15C.

The calculated density altitude (DALT) and true airspeed (TAS) will now be correctly displayed in the lower half of the Screen.

TO CALCULATE WINDS ALOFT (WIND) AND HEADWIND / TAILWIND COMPONENT (COMP)

1. Ensure you have followed the previous four steps so that TAS has been correctly calculated.

2. Move the cursor over the entry field next to the word HDG and enter the magnetic heading of the aircraft from your compass or DI. Default value on entry to this Screen is GPS track

The wind direction and speed (WIND) along with the head or tailwind component (COMP) will now be displayed in the lower half of the Screen.

When the wind has been calculated and you return to the map Screen by pressing Key 5, MAP, a wind arrow will be displayed on screen, correctly orientated and pointing at the aircraft icon to give a visual representation of the wind direction with respect to the aircraft. The wind arrow will disappear after 30 seconds.

VERTICAL NAVIGATION (VNAV)

VNAV is a function that tells the pilot when to start descending or climbing in order to reach a certain altitude at a certain distance from the next waypoint and is entered by pressing Key 3, VNAV, on Screen 57, E6-B Calculator Cover Screen. This function is not available in External GPS mode.

This function can only be switched on when a Flight Plan is being flown or a DIRECT TO is being executed, in other words, when there is a valid destination waypoint.

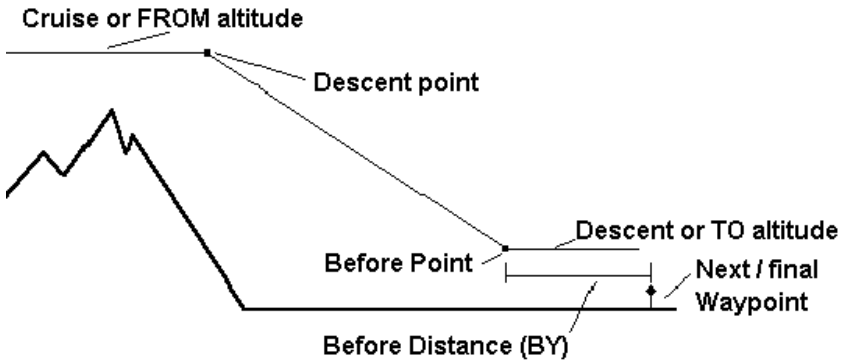

On entry to Screen 59, if there is no active waypoint the DESTINATION box will read NO WAYPOINT. You must have an active waypoint in order to activate VNAV Mode. The name of the destination waypoint will be shown if available, otherwise NO WAYPOINT will be displayed.

VERTICAL NAV	
FROM	+00249Ft
TO	+01500Ft
BY	05.0nm
AT	0500fpm
→ 10C GALT	
CLIMB IN:	--:--

57

PREV PAGE

V Nav setup page.
Enter cruise alt (FROM), final alt (TO), dist from next wpt (BY) and climb/descent rate (AT).

47

MAP

Screen 59: VNAV Setup Screen

Once in the VNAV Screen you must enter the cruise altitude (the altitude FROM which you will descend), the final altitude (the altitude TO which you want to descend), the rate of descent (in FPM feet per minute) and the distance before the upcoming waypoint that you want to achieve the new level BY.

On entry to this Screen, the FROM value will default to GPS altitude if your unit has an internal GPS receiver or to 5000 feet if your unit is in External GPS mode (or the last set value). The TO value will default to 1500 feet (or the last set value). The BY value will default to 5.0nm (or last set value) and the AT value will default to 500fpm (or last set value).

The DESCEND IN box will show an active countdown of the time left before you should start your descent and will be recalculated if you change any of the four variables (FROM, TO, BY or AT).

If Screen 59 is entered then exited by pressing Key 1, VNAV mode is not activated, the values are simply retained for use later in the flight.

If Screen 59 is entered then exited by pressing Key 5, Screen 47, 47A or 47B (NAV Mode) Screen will be displayed with the following changes.

E6-B Calculator

1. Key 5 will now read VNAV OFF and there is a new VNAV message box.
2. If the DESCEND IN counter is greater than 00:00, the new message box will show DESCEND IN with the counter value.
3. When the DESCEND IN counter reaches 00:00, the alarm will sound and a message will be displayed across the Screen saying START DESCENT NOW. Key 5 will change to ALARM OFF then back to VNAV OFF. Once Key 5 is hit or the alarm times out, the START DESCENT message will disappear and the VNAV message box will now show ADVISORY ALT: XXXXX ft and count down. The descent angle will be fixed at this point to prevent changes in ground speed from altering the descent profile.

When the advisory altitude is within 500 feet of the TO altitude, the alarm will sound again and a message will be displayed across the Screen saying FINAL ALT IMMINENT. Key 5 will change to ALARM OFF then back to VNAV OFF. Once Key 5 is hit or the alarm times out, the advisory altitude will continue to count down until it reaches the TO altitude. VNAV mode will then cancel automatically.

Should you wish to perform a DIRECT TO or select a new Flight Plan the VNAV Mode will need to be cancelled.

VNAV can be used for climbing as well as descending. If the FROM altitude is set to a lower value than the TO altitude then everywhere the words DESCENT and DESCEND appear, the word CLIMB will be used instead.

TRIP/FUEL PLANNING

This feature is entered by pressing Key 4, TRIP/FUEL, on Screen 57, E6-B Calculator Cover Screen, and allows you to call up any Flight Plan and view the following details about each leg of the Flight Plan. This feature can also be entered while flight planning from Screens 11 or 42, Flight Plan Selection Screens. This function is not available in External GPS mode.

1. BRG (Initial Track, True)
2. DIS (Leg Distance)
3. ETE (Leg Time)
4. REQ (Fuel Required for Leg)

And for the total Flight Plan:

1. DIS (Total Distance)
2. ETE (Total Flight Plan Time)
3. REQ (Total Fuel Required)

All you need to input is your cruising speed and your fuel burn. Fuel burn is entered in units / hour. The units are not important. If you fill your aircraft tanks using US gallons, enter your fuel flow in US gallons / hour.

On entry to Screen 60, the cursor will be positioned over the flight plan number. Default speed will be 120 knots and that last set. Default flow/hour will be 6.0 or that last set. Moving the joystick up and down alters the flight plan number. Moving the joystick right moves the cursor down to the leg selection. Moving the joystick left moves the cursor up to the flow and speed settings.

The screenshot shows a flight calculator interface. At the top, it displays: SPEED: 120 Kts, FLOW/HR: 006.0, and FPLN: 01. Below this is a section for LEG: START:NF NDB and 01:MARGATE, with a right-pointing arrow. To the right of this section is a 'PREV PAGE' button with '57 / 11' next to it. The next section shows calculated values: DIS:2.2, BRG:283M, ETE:0:01, and REQ:0.1. Below that is a box with 'FPLN DIS:21.0' and 'ETE:0:10 REQ:1.0'. At the bottom is a text box: 'Trip/fuel calculator page. Use joystick to select values and select a flight plan and leg.'

Screen 60: Trip / Fuel Flight Plan Select Screen

When using this function for the first time, move the cursor up to SPEED and set the cruise speed of your aircraft. Move the cursor down to FLOW/HR and set the fuel flow per hour for your aircraft. These settings will be permanently stored for later use.

Next move the cursor down and select the flight plan you want to perform the calculations for, then move the cursor down again and scroll through the legs of your chosen Flight Plan.

As you scroll through the flight plan, the seven calculated fields in the lower part of the Screen will be updated. The four values grouped together (DIS, BRG, ETE and REQ) are the DIS (Leg Distance), BRG (Initial Track, True), ETE (Leg Time) and REQ (Fuel required for Leg) for the leg displayed.

The three values grouped in the center of the screen (FPLN DIS, ETE and REQ) are the DIS (Total flight plan distance), ETE (Total flight plan time) and REQ (Total fuel required, no reserve) for the flight plan displayed.

SUNSET/SUNRISE CALCULATOR

This feature is entered by pressing Key 5, SUNSET/RISE, on Screen 57, E6-B Calculator Cover Screen, and allows you to calculate sunrise and sunset times for any point in the world. You will be asked to input a latitude, longitude and date. The sunrise and sunset time for that date will then be displayed in your local time.

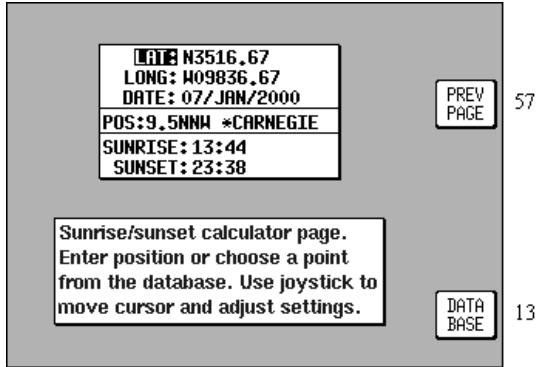

Screen 61: Sunset/Sunrise Calculator Screen

On entry to this Screen

the present or last known latitude and longitude will show. The present date (internal GPS only) will also show. If your unit is in External GPS mode, a default date value will be displayed.

You can now alter the latitude, longitude and time with the joystick or alter the latitude and longitude by choosing an item from the database. Key 5, DATABASE, calls Screen 13, Database Selection Screen, followed by 14 and 16. Once an item is selected, this Screen returns with the item's latitude and longitude and name showing.

The POS, SUNRISE and SUNSET fields are all re calculated each time you alter the position or date.

NOTE:

The Sunrise and Sunset times displayed on this screen are displayed in YOUR LOCAL TIME (i.e. UTC + your local offset), not the local time of the position selected. Allowance must be made if the position you have selected is in a different time zone from that for which the unit is set up for.

SETUP SCREENS

Your KMD 150 unit allows you a great deal of flexibility to customize it to suit your own wishes and requirements. It also contains a high level of automatic self-testing and diagnostics. All customization and diagnostic functions are grouped together in this Setup section.

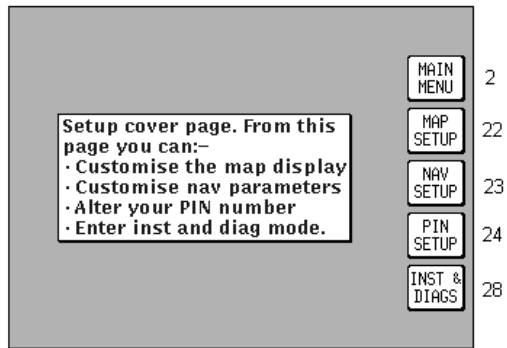

Screen 21: Setup Cover Screen

To access Screen 21, Setup Cover Screen, press Key 4, SETUP, in Main Menu.

Key 1 returns you to Screen 2, Main Menu

Key 2 gives access to Screen 22, Map Customization Screens.

Key 3 gives access to Screen 23, NAV Mode Customization Screen (only available when using the internal GPS).

Key 4 gives access to Screen 24, Personal Identification Number (PIN) Setup Screens.

Key 5 gives access to Screen 28, Installation and Diagnostic Screens.

MAP SETUP SCREENS

To access Screen 22, Map Customization Screen, press Key 4, SETUP, in Main Menu, followed by Key 2, MAP SETUP, in Screen 21, Setup Cover Screen.

When this Screen first appears you will always see the current settings with a cursor over the words **ORIENTATION**. You can then use the joystick to move the cursor up and down the list of

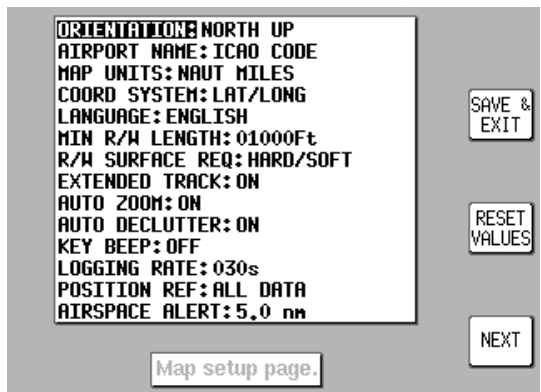

Screen 22 : Map Customization Screen

Setup Screens

headings. When the cursor is over the heading you wish to alter, move the joystick to the right. This will in turn move the cursor over to the set of options available for that heading. Moving the joystick up and down will then allow you to scroll through these options.

The various settings available for each heading are listed below. The default settings are those shown in the previous illustration. To reset the values on this Screen (or Screens 22A, 22B and 22C) to their defaults, press Key 3 RESET VALUES. This will reset the values on the displayed screen only. In order to reset all user defined data globally, see the Clear Memory screens later in this section.

SETTINGS AVAILABLE

ORIENTATION: track up / north up.

AIRPORT NAMES: ICAO code / full name / City name.

MAP UNITS: nautical miles / statute miles / kilometers.

COORD SYSTEM: LAT/LON / OSGB / UTM.

LANGUAGE: English / French / German / Spanish.

MIN R/W LENGTH: selectable from 0 to 15,000.

R/W SURFACE REQUIRED: hard/soft / hard.

EXTENDED TRACK: on / off.

AUTO ZOOM: off / on.

AUTO DECLUTTER: on / off

KEY BEEP: on / off.

LOGGING RATE: selectable between 000 and 999 secs.

POSITION REF: all data / VORs / VORs & Airports

ORIENTATION: This allows you to choose whether to have the map displayed with north at the top of the screen or orientated to have the aircraft's track aligned up the screen. If set to Track Up, when your ground speed is below 3 knots, the unit will automatically revert to North Up orientation.

AIRPORT NAMES: This gives you the option of labeling the airport icons on the map with the full names of the airports (long ones truncated to 9 characters), the full names of the city associated with the airport or the ICAO 3 or 4 letter location indicators.

MAP UNITS: This allows you to specify the units in which the scale bar and all navigation information will be displayed. If nautical or statute miles are selected, all lengths and altitudes will be reported in feet. If

kilometers are selected, all lengths and altitudes will be reported in meters.

COORD SYSTEM: This option controls whether the unit operates with reference to Latitude/Longitude or UTM or OSGB grid references.

LANGUAGE: This is self-explanatory; it enables you to choose the language in which you would prefer the unit to operate.

MIN R/W LENGTH: This allows you to set the minimum length of main runway at the airports that will be displayed when you ask the unit to display the ten nearest airports. The minimum length can be specified in steps of 1 foot from 0 to 15,000 feet. By setting a minimum length you can force the unit to search for and display only airports with runways, which are equal to or longer than the pre-set minimum length.

R/W SURFACE REQUIRED: R/W Surface Required is also used when searching for the ten nearest airports in map mode. If set to hard/soft, airports with either hard or soft runways will be displayed. If set to hard, only airports with hard runways will be displayed and soft-runway airports ignored.

EXT TRACK: If Extended Track is turned on, you will see an extended track line drawn ahead of your present position in the direction of your present track. This can sometimes be useful to see just where the aircraft would end up if the present heading were maintained. Alternatively you can dispense with this map feature simply by selecting EXT TRACK to OFF.

AUTO ZOOM: Auto Zoom is a useful function to use as you approach your destination. When flying the last leg of a Flight Plan or when flying a DIRECT TO, the zoom range is automatically adjusted. The unit selects the lowest zoom setting that will show the destination and the current aircraft position on the same map image. This automatic selection of the optimum zoom range continues until either the final destination is reached, the flight plan or DIRECT TO is cancelled, or the pilot manually adjusts the map zoom by pressing the ZOOM IN or ZOOM OUT keys.

AUTO DECLUTTER: This unique feature makes the map more readable in areas of high data density by removing unimportant icon labels. Each time the map is redrawn, the data displayed is built up in layers starting with the least important data classes (towns etc) and building up through to the most important data class (airports). If Auto Declutter is switched on, as the map is being built, if a higher priority icon label is found to clash with a lower priority icon label already on the screen, the lower priority icon label will be removed. This prevents icon label overlaps and clashes and hence declutters the map.

Setup Screens

KEY BEEP: This allows you to select the beep that occurs when you press a key or move the joystick on or off.

LOGGING RATE: This gives you the choice of tuning off the LOG TRAIL or setting how often your position is stored in memory for playback in Demo Mode or to a PC. A total of 2000 fixes are stored in continuous wrap around memory (i.e. newest data overwrites oldest). To calculate total logging time, divide 2000 by the logging rate per minute (30 sec logging rate = 2 per minute). This will give the total logging time in seconds (i.e. 2000 points divided by 2 = 1000 minutes = 16 hours 40 mins).

POSITION REF: This is the geographical item used to describe your position to you in Map Mode. Please refer to the Map Mode Screens Section of this manual for more details.

AIRSPACE ALERT: This allows you to turn on, off or set the distance from an airspace boundary at which the alert annunciation is displayed. May be set from 0.5 to 10.0 statute or nautical miles, whichever has been selected in the MAP UNITS discussed previously.

Screens 22A, 22B and 22C, the Data Class Setup Screens are accessed by repeatedly pressing Key 5, NEXT. If there are too many items to be displayed on any of the data class screens they will be split across two screens. It is impossible to include every item from the database within the graphic map display, especially when zoomed out to the smaller scale maps. The Data Class Setup Screens allows you to choose the level of zoom at which you wish each of the classes of data to become visible and at which level of zoom you want their corresponding labels to become visible. You can also select different aircraft icons to represent your present position when in Track Up mode, however zoom level settings are not available for the aircraft icon because it must be visible at all zoom levels. You can set many of the data classes display colors for both Topo On and Topo Off display modes and also set the icon or line style for several of the data classes.

ITEM	ICON	TOPO		ICON MAX	NAME MAX	MIN	
		ON	OFF				
AIRPORTS	●	■	■	30	15	0.5	SAVE & EXIT
VORs	⊗	■	■	30	15	0.5	
NDBs	⊗	■	■	15	8	0.5	RESET VALUES
USER MPTs	◆	■	□	15	8	0.5	
INTs	▲	■	■	OFF	OFF	0.5	NEXT
HELIPADS	Ⓜ	■	OFF	OFF	OFF	0.5	
HELIREPS	■	■	OFF	OFF	OFF	0.5	
CITIES	▲	■	OFF	15	8	0.5	
OBSTACLES	人	■	■	30	8	0.5	
AIRCRAFT	✈	N/A	N/A	N/A	N/A	N/A	
LOG TRAIL	OFF	N/A	N/A	N/A	N/A	N/A	

Screen 22A: Point Features Data Class Setup Screen

NOTE:

Not all point features are available in all database regions. Only those listed on your unit are available for display in your database region.

To do this you have to select for each database class an ICON or LINE style, A Topo On Mode color, a Topo Off Mode color, an ICON or LINE MAX zoom level (the maximum zoom level at which the icon or line will be displayed), a NAME MAX zoom level (the maximum zoom level at which the name label will be displayed) and a MIN zoom level (the minimum zoom level at which both the icon/line and name will be displayed). The default levels are those shown in the illustrations.

You will notice that there is a limited choice of icon styles for some data classes, this is intentional in order to keep the important data (such as airports) displayed in a recognizable form. You will also notice that some settings have N/A in their columns and are not adjustable. These are items that have fixed

values and are not user adjustable. A good example of this is that you can not set up a color for the urban areas in Topo Off Mode because no cartography is displayed in Topo Off Mode.

Not all data classes shown in the illustrations are available for all geographic areas. Details of the data classes available on the database card you have installed are available from Honeywell.

Please think carefully before altering any of the settings on these screens. You may inadvertently switch off an important data class (such as obstacles), which could compromise your situation awareness.

ITEM	LINE	TOPO		LINE MAX	NAME MAX	MIN	
		ON	OFF				
AIR ROUTES	---	<input type="checkbox"/>	<input type="checkbox"/>	OFF	OFF	0.5	SAVE & EXIT
MAJOR ROADS	==	<input type="checkbox"/>	N/A	15	8	0.5	
PRIME ROADS	---	<input type="checkbox"/>	N/A	8	4	0.5	RESET VALUES
OTHER ROADS	---	<input type="checkbox"/>	N/A	4	3	0.5	
RAILROADS	++	<input type="checkbox"/>	N/A	8	N/A	0.5	NEXT
RIVERS/LAKES	---	<input type="checkbox"/>	N/A	90	N/A	0.5	
V AIRWAYS	---	<input type="checkbox"/>	<input type="checkbox"/>	OFF	OFF	0.5	
TERRAIN	N/A	N/A	N/A	90	N/A	0.5	
SEA	N/A	<input type="checkbox"/>	N/A	N/A	N/A	N/A	
URBAN AREAS	N/A	<input type="checkbox"/>	N/A	N/A	N/A	N/A	
BACKGROUND	N/A	<input type="checkbox"/>	N/A	N/A	N/A	N/A	

Screen 22B: Line Features Data Class Setup Screen

ITEM	TOPO		LINE MAX	NAME MAX	MIN	
	ON	OFF				
AIRPORTS	<input type="checkbox"/>	<input type="checkbox"/>	50	30	30	SAVE & EXIT
CLASS A/B/C	<input type="checkbox"/>	<input type="checkbox"/>	30	15	0.5	
CLASS D	<input type="checkbox"/>	<input type="checkbox"/>	30	15	0.5	RESET VALUES
CLASS E/F/G	<input type="checkbox"/>	<input type="checkbox"/>	15	8	0.5	
CLASS UNKNOWN	<input type="checkbox"/>	<input type="checkbox"/>	30	15	0.5	NEXT
DANGER	<input type="checkbox"/>	<input type="checkbox"/>	50	30	0.5	
RESTRICTED	<input type="checkbox"/>	<input type="checkbox"/>	50	30	0.5	
PROHIBITED	<input type="checkbox"/>	<input type="checkbox"/>	50	30	0.5	
MIL/MATZ	<input type="checkbox"/>	<input type="checkbox"/>	30	15	0.5	
OTHER SUA	<input type="checkbox"/>	<input type="checkbox"/>	50	30	0.5	

Screen 22C: Airspace Data Class Setup Screen

NAV MODE SETUP

This screen is not available in External GPS mode. When you first enter this Screen the current settings are displayed with a cursor over the words **CDI SCALE**. You then have to use the joystick to move the cursor up or down. Once the cursor is over the heading you wish to alter, moving the joystick to the right will move the cursor over to the set of options available for that heading.

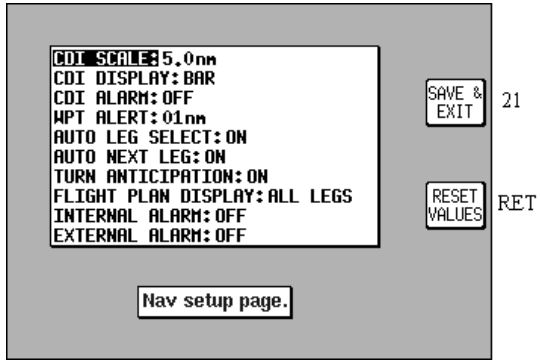

Screen 23: NAV Mode Customization Screen

The various settings available for each heading are listed below. The default settings are those shown in the previous illustration. To reset the values on this screen to their defaults, press Key 3 **RESET VALUES**. This will reset the values on the displayed screen only. In order to reset all user defined data globally, see the **Clear Memory** screens later in this section.

CDI SCALE: 0.3 / 1.0 /2.5 /5.0nm.

CDI DISPLAY: bar / numeric / off

CDI ALARM: on / off.

WPT ALERT: 1 / 2 / 3 / 4 / 5 / 6 / 7 / 8 / 9 / 10 / 11 / 12 / 13 / 14 / 15 / 16 / 17 / 18 / 19 / 20 nm

AUTO LEG SELECT: on / off.

AUTO NEXT LEG: on / off.

TURN ANTICIPATION: on / off

FLIGHT PLAN DISPLAY: active leg / all legs.

INTERNAL ALARM: on / off.

EXTERNAL ALARM: on / off.

CDI SCALE: This enables you to choose which of the given distances you want the unit to use as the setting for the full-scale deflection of the Course Deviation Indicator (CDI) in NAV mode. This value is always in nautical miles.

CDI DISPLAY: This allows you to set the CDI display in Map Mode to show either a bar-graph, or a numeric read-out of course deviation or to

be switched off. If selected OFF, the CDI is no longer shown while you are in Map Mode.

CDI ALARM: When selected ON this produces an audible alarm to tell you when full-scale deflection of the CDI has been reached. If you choose to set this to OFF, you disable this alarm.

WPT ALERT: You can use this feature to set the distance away from a flight plan turning point, or final destination, at which you wish the audio and visual arrival alarm to be activated. This value is always in nautical miles.

AUTO LEG SELECT: If you select this ON, the unit will automatically place the cursor on the closest leg when Screen 12, Flight Plan Program/Edit Screen, is accessed to select the Flight Plan. Although the nearest leg to your present position is highlighted, an alternative leg may be selected by using the joystick. If AUTO LEG SELECT is switched OFF the cursor will simply be positioned over the first leg in the Flight Plan whenever Screen 12 is selected.

AUTO NEXT LEG: If you select this option ON then, as each waypoint in the Flight Plan is passed, the next leg will be automatically selected. You thus do not need to press Key 1 (the NEXT LEG Key) as this function produces the same effect automatically. If you select AUTO NEXT LEG to OFF, you will then need to activate the next leg in the Flight Plan manually by pressing Key 1 (the NEXT LEG Key) at the end of each leg, otherwise your unit will continue to give you distance and bearing information to your previous waypoint.

TURN ANTICIPATION: Turn Anticipation provides navigation along a curved path segment to ensure a smooth transition between two adjacent legs in the flight plan. If turned ON, Auto Next Leg will also automatically turn on. Auto Next Leg is an essential part of turn anticipation. Please refer to Arrival at an Enroute Waypoint in the Map Mode with NAV Information Screens Section of this manual for more details.

FLIGHT PLAN DISPLAY: Allows all legs in the active Flight Plan to be displayed or just the active Flight Plan leg to be displayed when flying a Flight Plan.

INTERNAL (WPT and CDI) ALARM: This gives you the choice between having these internal alarms functioning or inactive.

EXTERNAL (WPT and CDI) ALARM: This gives you the choice to switch ON or OFF the output from the unit, which can drive an external alarm device.

PERSONAL IDENTIFICATION NUMBER (PIN) SETUP

We have provided the security feature of a Personal Identification Number (PIN) in your KMD 150 unit with the main aim of preventing unauthorized persons from using your navigation equipment. You may use this Screen to set up your own choice of a four-digit personal number. This can be any permutation of the figures 1, 2, 3, and 4, e.g. 4412, 2433, 3124 etc.

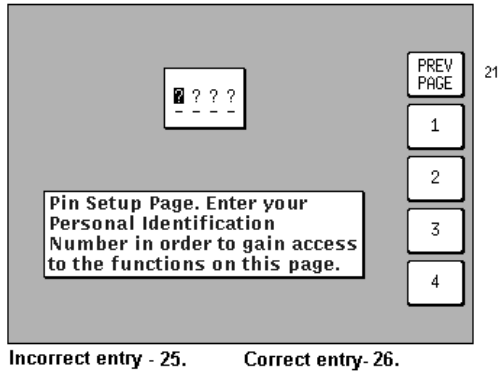

Screen 24: PIN Setup Cover Screen

To access Screen 24, Pin Setup Cover Screen, press Key 4, SETUP, in Main Menu followed by Key 4, PIN SETUP, in Screen 21, Setup Cover Screen. On entry to this Screen you will find the cursor positioned over the first of four question marks. The joystick is not active and the current four-digit PIN must be entered by pressing Keys 2, 3, 4, and 5 (now labeled 1, 2, 3 and 4 as in the previous illustration). The default PIN number that will be set when you receive the unit, is 1234.

As you enter each number by pressing each of the relevant keys once, in the order that matches the PIN, each question mark in turn is replaced by an asterisk and the cursor moves one step to the right. When the last digit is entered, if you have failed to enter the correct four digits, Screen 25 will be displayed.

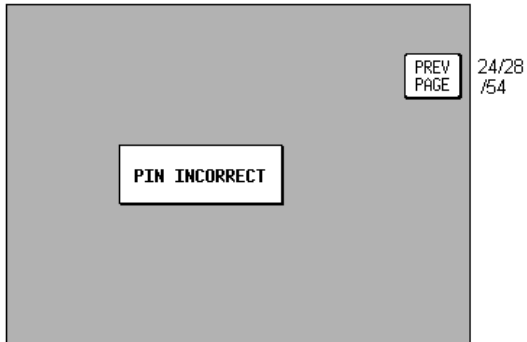

Screen 25: PIN Incorrect Screen

If you get this PIN INCORRECT message, just press Key 1 PREV PAGE and you go back to Screen 24 where you can make another attempt to enter the correct PIN. Unlike many bank Automatic Teller Machines, there is no limit to the number of attempts you can make to input the correct PIN to your KMD 150 unit. Should you have the misfortune to forget your number, keep trying; there are only 256 permutations!

If you have managed to get the PIN correct then you move straight to Screen 26 as illustrated previously. On entry to this Screen, the current PIN is displayed and the status of the AUTO POWER-ON LOCK is displayed. The default selection for this is DISABLED. If you wish to activate this power-on lock, pressing Key 3, AUTO LOCK, will change the setting to ENABLED.

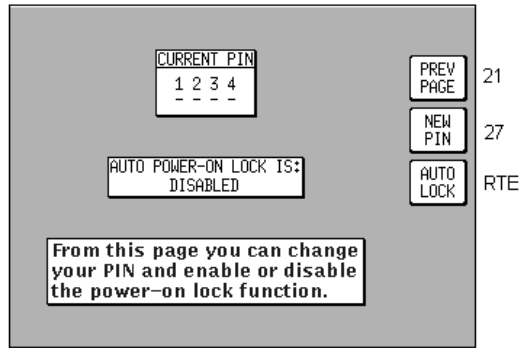

Screen 26: PIN Change & Power-On Lock Enable Screen

Pressing Key 1 returns you to Screen 21, the Main Setup page.

Pressing Key 2 takes you into Screen 27 where you are able to change the PIN.

When you access this Screen the cursor will be sitting over the first question mark. This represents the first digit of the PIN. Your new PIN can be entered from here by pressing Keys 2,3,4 or 5 (now labeled 1,2,3, and 4 in the previous illustration). The numbers you enter will replace the question marks as they are entered and the cursor will step to the right.

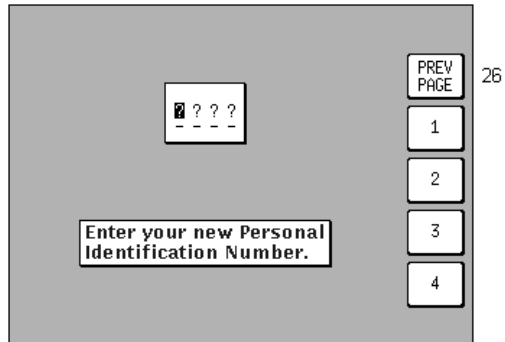

After last digit entry- 26.

Screen 27: PIN Change Screen

When the fourth digit has been entered, the new PIN will automatically be transferred to the unit's Non Volatile Memory (NVM) and Screen 26 will be displayed, showing the newly entered PIN. If you wish, you may press Key 1 at any time and this will take you straight to Screen 26 without making any change to the original PIN.

AUTO POWER-ON LOCK

Pressing Key 3, AUTO LOCK, on Screen 26, Pin Change & Power On Lock Enable Screen, allows you to switch the Auto Power-On Lock security feature ON or OFF. If you ENABLE the Power-On Lock, the unit will require your PIN to be entered every time you or anyone else switches it on. Although, as mentioned previously, so long as the Power-On Lock has not been activated, you can key in as many PIN attempts as you wish, once it has been ENABLED however the situation changes entirely.

If an incorrect PIN is then entered three consecutive times at the switch-on stage, the unit will lock out and display Screen 55 (see Appendix 1). If this happens to you, in order to re-activate the unit, you will have to telephone Honeywell or your Bendix/King dealer (or Skyforce Avionics Ltd. if in the United Kingdom). You will require the Serial Number of your unit and the Lock-Out Number, which you can read from the top of Screen 55. The operator at your dealer or at Honeywell will verify these details and check them against the Honeywell database and register of stolen units.

Once the operator is satisfied that the unit has not been stolen and that you are the officially recognized owner, you will be given an Unlock Code Number. This Unlock Number is a 10-digit number. In order to unlock your unit you must now enter this number correctly into your unit, still using Screen 55. The digits will replace the question marks as each one is keyed in. The unit regards the Unlock Number as having been entered as soon as the last digit has been keyed in. Every time an incorrect Unlock Number is entered, the unit will generate a new LOCK OUT number. This makes it impossible for a would-be thief to stumble upon the Unlock Number by trial and error. The odds against a thief guessing the correct Unlock Code Number are 10 million to 1.

If you do ever get into a Lock-Out situation and then re-activate your unit with the Unlock Code Number received from Honeywell, remember that no matter what PIN you were using before, the PIN will now have been reset to the default digits of 1234.

NOTE:

Be very careful if you activate the Auto Power On Lock feature. Locking yourself out of the system can be very inconvenient.

INSTALLATION AND DIAGNOSTIC SCREENS

This Screen is accessed by pressing Key 4, SETUP, in Main Menu followed by Key 5, INST & DIAGS, in Screen 21, Setup Cover Screen. Screen 28 gives you access to all installation and test-related Screens, and will allow you to perform diagnostic checks on the data input and output lines.

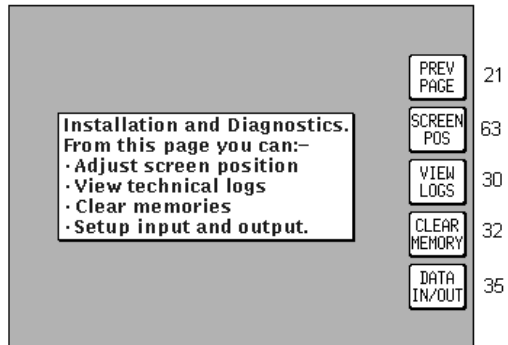

Screen 28: Installation and Diagnostics Cover Screen

You can also use this Screen to gain full access

to the "time in service" logs and "last flight" log. It is used, in addition, to enter four different "Memory Clear" routines, which are PIN-protected to prevent inadvertent erasure to the unit's memory.

Key 1 returns you to Screen 21, Setup Cover Screen.

Key 2 calls Screen 63, Screen Position Setup Screen.

Key 3 calls Screen 30, Engineering Log Screen.

Key 4 calls Screen 32, Memory Clear Entry Screen.

Key 5 calls Screen 35, Data In/Out and Test Screen.

SCREEN POSITION SETUP

Screen 63 is for use during manufacture to position the picture centrally in the viewable area of the display. This screen is also used to focus the image on the display. It is not a Screen, which you as a user of the KMD 150 should need to access so it is protected by an engineering PIN code to prevent accidental alteration of the factory settings.

VIEW LOGS

Engineering Log

This Screen can be used to produce technical engineering information about the unit. Unit type, serial number and build date information were all stored within the Non Volatile Memory at the time your unit was initialized at the factory. The version of the software in use and the latest update information are stored on the database card.

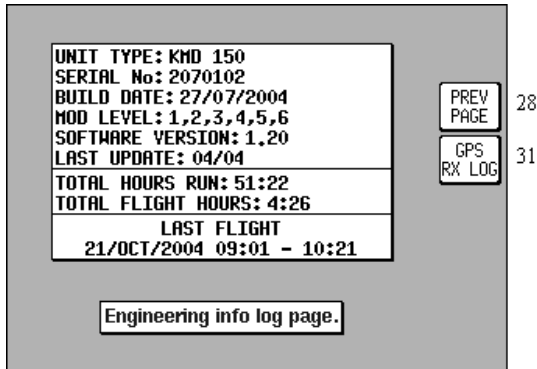

Screen 30: Engineering Log Screen

The Total Hours Run value is updated every minute. This can give you an indication of the total time that the unit has been in operation. You can, however reset this figure, using Screen 33. The Total Flight Hours is a value stored in exactly the same way as Total Hours Run, the difference between these two figures being due to the fact that Flight Hours are totaled only during periods when the Ground Speed is above 30 knots. Last Flight data is available only with the KMD 150. The Date and Start Time are logged as soon as the Ground Speed exceeds 30 knots and the Stop Time is logged whenever the Ground Speed drops back to less than 30 knots. Key 2, GPS RX LOG, is available only on KMD 150 units and gives access to the GPS Receiver Engineering Log Screen 31.

GPS Receiver Information Log

Most of the information on this Screen is technical engineering information about the internal GPS receiver circuitry. The Total Fix Hours figure increases only during the periods when the GPS receiver has a 2D or 3D fix. You can if you wish also reset these

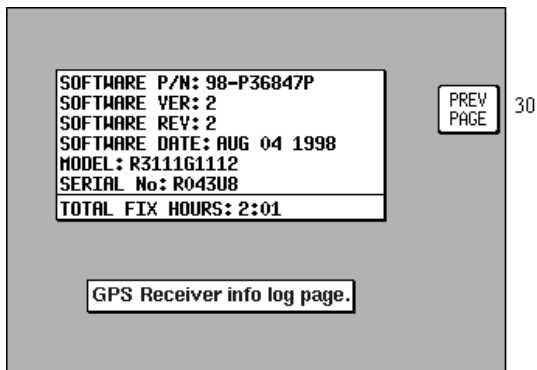

Screen 31: GPS Receiver Information Screen (Internal GPS Units Only)

figures along with the Total Unit Hours Run value by using Screen 33, Memory Clear Screen.

CLEAR MEMORY

All the routines, which can clear the unit's memory, are protected by your PIN specifically to prevent any unauthorized person wiping out the valuable data contained in memory. Therefore, when you enter this Screen the cursor will be positioned over the first of four question marks. You must enter your PIN at this stage before you can proceed to the memory clear functions on Screen 33. (The factory default PIN is 1234). As soon as the fourth digit of a correct PIN is entered, the unit will call Screen 33. If the PIN entered is incorrect the display will switch immediately to Screen 25 (PIN INCORRECT) and then take you back to Screen 28, the Cover Screen for Installation and Diagnostics. If you do make a mistake, however, you are allowed to make as many attempts as you need to enter the correct PIN.

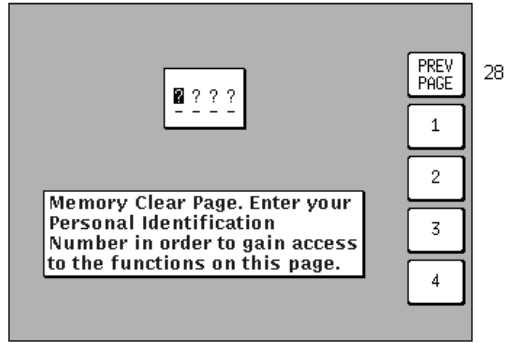

Screen 32: Memory Clear Entry Screen

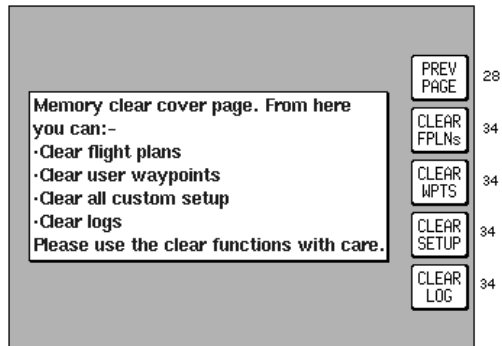

Screen 33: Memory Clear Cover Screen

Be careful to handle operations from this Screen correctly, otherwise you could lose valuable and important data from the memory of your unit.

If for instance you press Key 2, labeled "CLEAR FPLNs", you will go straight to a warning Screen that reads "Clear Memory. ARE YOU SURE?" If you then press Key 1 labeled "PREV PAGE" it will take you back to Screen 33 again, without erasing any of the memory. If however you decide to go ahead and press Key 5 labeled "YES" then all the Flight Plans in memory will vanish from the unit's memory and you will not thereafter be able to recall this information.

Setup Screens

If you press Key 3, labeled "CLEAR WPTS", a similar procedure will be followed, and pressing, "YES" will this time clear all User waypoints from memory including those being used in Flight Plans.

Use of Key 4, labeled "CLEAR SETUP", will reset all the User-Defined Options within the unit to their original default values. This also clears the Note Pad memory.

Key 5, labeled "CLEAR LOG", resets the Total Time Run counters that appear on Screens 30 and 31. This also clears the last flight time log and the 2000 in flight logged points from memory.

Key 1, labeled "PREV PAGE", returns you to Screen 28 without altering or erasing anything in the unit's memory.

DATA IN/OUT

On entry to this Screen, details of the current settings for data output are displayed in the top box and a cursor is positioned over the words DATA OUTPUT. Settings for data output can be adjusted using the joystick and the options available are as follows. (The default settings are listed first.)

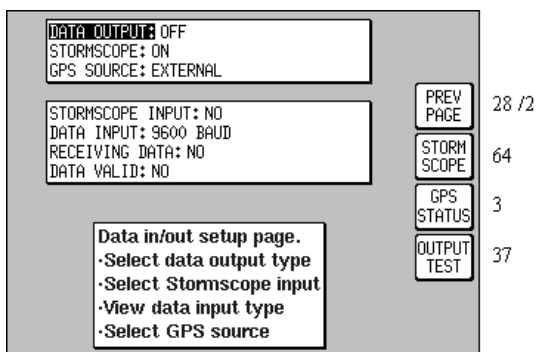

Screen 35: Data Input/Output Setup and Test Screen

External GPS Source selected: DATA OUTPUT: OFF /
ECHO INPUT.

Internal GPS Source selected: DATA OUTPUT: OFF /
RS232 (AR NAV) / NMEA
0183

Data output when using an external GPS receiver is limited to echoing the data input. This provides a useful RS232 buffer for connecting other listening devices to the host GPS data output.

KMD 150 with GPS can output standard aviation RS232 data or NMEA 0183 format RMC and GGA sentences at 9600 baud.

Below the DATA OUTPUT setting is the STORMSCOPE setting. If the KMD 150 is interfaced to a L-3 Communications WX-500 Stormscope® sensor, this option should be selected to ON. If selected ON, Key 2 will be labeled STORMSCOPE and will give access to screen 64, the Stormscope® diagnostics cover page. These are not screens, which you as a user of the KMD 150 should need to access, however if further

information on these screens is required please refer to the KMD 150 Installation Manual for all Stormscope® diagnostic related functions. If you do not have a Stormscope® connected, ensure this option is switched off.

Below the STORMSCOPE setting is the GPS SOURCE setting. This allows you to use either the KMD 150's internal GPS receiver or an external GPS/LORAN receiver. When you move the cursor to the right of this field the following Warning / confirmation request shall be displayed:

**Screen 35B: GPS Source Change
Warning Screen**

If you press Abort the GPS source remains unchanged. If you press Yes, you can use the joystick to toggle the GPS SOURCE between INTERNAL and EXTERNAL. When set to INTERNAL, the internal GPS receiver will be used. When set to EXTERNAL, the KMD 150 will use data generated by an external GPS/LORAN receiver.

NOTE:

If you are installing a non-GPS version of the KMD 150, the internal option will not be available.

When KMD 150 is used with an external GPS source, the data output will be limited to OFF and ECHO INPUT.

The second box is for information only and will only appear if the GPS SOURCE is set to EXTERNAL or if the Stormscope® interface is switched ON. If the Stormscope® interface is switched on, the presence of incoming Stormscope® data is indicated by the word YES next to the STORMSCOPE INPUT: heading.

EXTERNAL GPS DATA INPUT OPTION

If you are installing the non-GPS version of KMD 150 or as an alternative to using the internal GPS receiver, an external GPS/LORAN is to be used, the KMD 150 requires a data input to function in Map Mode. To operate correctly the KMD 150 requires a 9600 baud Trimble TNL, Garmin AIU or King equivalent ARNAV R-30 sentence. Alternatively a 4800 or 9600 baud NMEA 0183 data sentence containing latitude, longitude, track, ground speed and variation information with an RMC header may be used.

Setup Screens

Once the physical connection to the host GPS or LORAN has been made, it is essential to select an appropriate data output on the host unit. This can be done by referring to the manual for the host GPS/LORAN and choosing an option that corresponds to one of the compatible data input types listed previously.

If the host GPS or LORAN is correctly connected, switched on and outputting data, the KMD 150 will automatically start to read and decode the incoming data. There is no need to set an input type on the KMD 150 as this is done automatically.

After a few seconds if data is being received, the word YES will appear next to the RECEIVING DATA: heading. The type of data being received will then be displayed beside the DATA INPUT: heading.

If the data being received contains valid fix information (i.e. the host GPS has a fix) the word YES will appear next to the DATA VALID: heading. Once the unit is receiving and validating the incoming data select PREV PAGE and return to the MAIN MENU Screen.

OUTPUT TEST

If you are installing an Internal GPS version of the KMD 150 and have made connection to other avionics equipment on the aircraft, screen 37 allows you to run some installation tests. Screen 37 is accessed by pressing Key 4 (OUTPUT TEST) on Screen 35. Once the tests are complete, return to screen 35 by pressing key 1 (PREV PAGE).

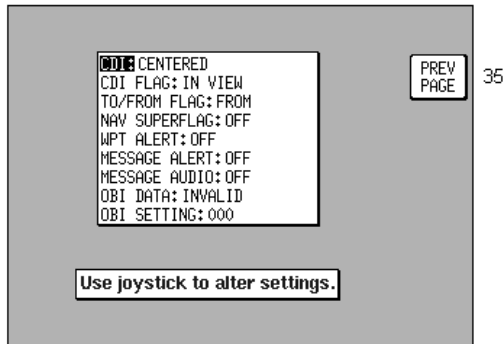

Screen 37: Aviation Interface Output Test Screen

The following flags and commands can be functioned from the OUTPUT TEST screen:

CDI

- | | |
|------------------------|---|
| Full Scale (FSD) Left | Ensure CDI is deflected full scale left (5 dots) |
| Full Scale (FSD) Right | Ensure CDI is deflected full scale right (5 dots) |
| Centered | Ensure that the CDI is centered |

CDI FLAG

In View	Ensure CDI or NAV flag is visible
Out of View	Ensure CDI or NAV flag is not visible

TO/FROM FLAG

TO	Ensure TO flag is visible
FROM	Ensure FROM flag is visible
FLAG OUT OF VIEW	Ensure TO and FROM are not visible

NAV SUPERFLAG

ACTIVE	Ensure Nav Superflag is active
INACTIVE	Ensure Nav Superflag is inactive

WPT Alert

OFF	Ensure the WPT Annunciator is OFF
ON	Ensure the WPT Annunciator is ON

Message Alert

OFF	Ensure the MSG Annunciator is OFF
ON	Ensure the MSG Annunciator is ON

Message Audio

OFF	Check Audio output is OFF
ON	Check Audio outputs is ON

OBI/RMI

VALID	Ensure that OBI/RMI output reads the selected value
INVALID	Ensure that the OBI/RMI is INVALID

OBI SETTING

Set in steps of 45°	Use in conjunction with the above to test OBI/RMI
---------------------	---

Intentionally left blank

STORMSCOPE® OPERATION

INTRODUCTION

Your Bendix/King KMD 150 is capable of being interfaced to a L-3 Communications WX-500 Stormscope® Series II Weather Mapping Sensor. The WX-500 detects electrical discharges associated with thunderstorms within a 200 nm radius of the aircraft. The information is then sent to your KMD 150 that will display the location of the thunderstorms both on the map screens and on a dedicated Stormscope® screen.

The WX-500 Stormscope® Sensor is a passive system that listens for electromagnetic signals with a receiving antenna. There's no transmitter and no harmful transmissions. The system operates as well on the ground as in the air, thereby giving the pilot important planning information even before takeoff.

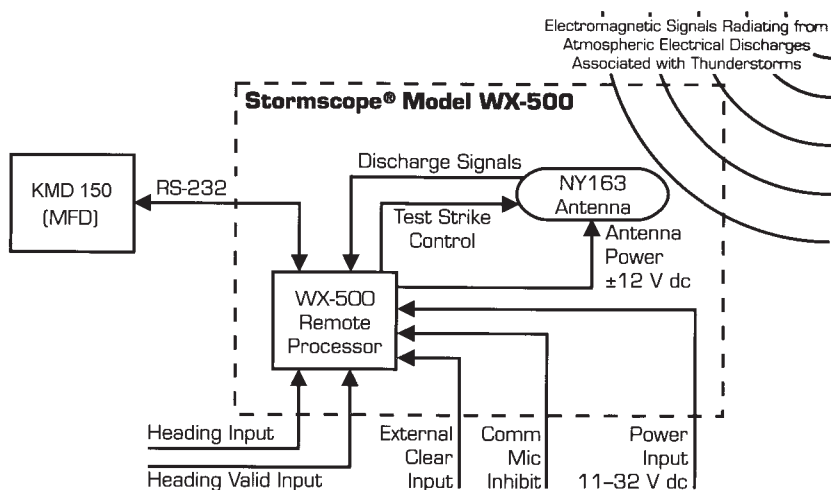

Figure 13-1- Functional Diagram

FUNCTIONAL DESCRIPTION

The antenna detects the electric and magnetic fields generated by intra-cloud, inter-cloud, or cloud-to-ground electrical discharges that occur within a 200 nm radius of the aircraft and sends the resulting "discharge signals" to the processor. The processor digitizes, analyzes, and converts the discharge signals into range and bearing data then stores the data in memory. The WX-500 processor then communicates this information to the KMD 150 as 'strikes' and 'cells'. The WX-500 updates the KMD 150 every two seconds.

CELL DISPLAY MODE

When viewing the dedicated Stormscope® screen, if cell display mode is selected, the KMD 150 plots a "+" symbol (discharge point) on the display when it detects associated discharges within the selected range and view. The KMD 150 will plot another "+" close to the first for each additional discharge determined to be associated with the group. The KMD 150 will not plot a "+" for any discharge not associated with a group unless it's detected within a 25 nm radius of the aircraft. The effect of this clustering algorithm is to display the location of storm cells instead of individual discharges. The cell display mode is most useful during periods of heavy electrical discharge activity. Using the cell display mode during these periods frees the pilot from sifting through a screen full of discharge points to determine exactly where the storm cells are located.

STRIKE DISPLAY MODE

If the strike display mode is selected, the KMD 150 immediately plots an "x" symbol (discharge point) on the display for each individual discharge it detects within the selected range and view. The strike display mode plots discharge points on the display in relation to where the discharges are actually detected instead of plotting them close to an associated group of discharge points as is done in the cell display mode. The strike display mode is most useful during periods of light electrical activity because it may plot discharges associated with a building thunderstorm sooner than the cell display mode would.

STORMSCOPE® MODE FEATURES

- Two viewing modes:
 - 360° view of surrounding airspace
 - 120° forward view
- Two processing modes:
 - Strike Mode
 - Cell Mode
- Heading stabilization - automatically repositions discharge points on the display relative to the latest aircraft heading using either GPS track or a compatible heading system.
- Local and remote clear - allows operator to clear displayed discharge points using a button on the front of the KMD 150 or from a remotely - mounted "clear screen" button (not supplied).

- Discharge rate indicator-displays estimated average discharge rate per minute for current range and view.
- Mic inhibit - inhibits thunderstorm processing when the communications transmitter is keyed to prevent the processing of corrupted data (some aircraft need to use this feature, others don't).

ANATOMY OF A THUNDERSTORM

The Stormscope® model WX-500 is intended to help pilots avoid the dangers associated with thunderstorms (convective wind shear, lightning, icing, tornadoes, etc.). The WX-500 locates thunderstorms by detecting the electrical discharges that thunderstorms always generate. Figure 13-2 shows how thunderstorms create electrical discharges and radiate electromagnetic signals.

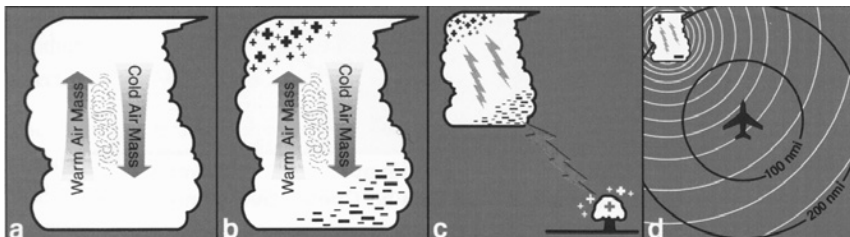

Figure 13-2 - Electrical Discharges in Thunderstorms

- The convective flow of air currents (warm air going up and cold air going down) leads to friction between the opposing air currents and wind shear in the space between the opposing air currents. The closer together the opposing air currents are, the greater the shearing force of the air currents.
- The friction between the opposing air currents causes electrical charges in the area to separate. As positive (+) and negative (-) electrical charges are separated, they accumulate in masses of similar charges (positive charges near the top of the cloud and negative charges near the bottom).
- Electrical discharges occur as the accumulated masses of separated positive and negative charges attempt to rejoin. These discharges continue to occur repetitively as long as the convective wind shear persists. A few of the discharges are visible as lightning, but most electrical discharges occur within a cloud or between clouds and are hidden by those clouds. Only a small percentage of discharges occur between the clouds and the ground. Cloud to ground lightning occurs when the negatively charged lower part of a cloud induces a positive charge on an object on the ground. The immense charge separation finally breaks down the insulating air and a discharge occurs dumping negative charge from the cloud onto the object and the surrounding ground.

d) All electrical discharges radiate electromagnetic signals in all directions at the speed of light. The electromagnetic signals have unique characteristics and varying rates of recurrence and signal strength. Figure 13-3 shows that the rate of electrical discharges detected in an area is directly related to the amount of convective wind shear turbulence present. In fact, as convective wind shear increases, the rate of electrical discharges increases at an increasing rate. This relationship means that if you find the electrical discharges, you've found the wind shear.

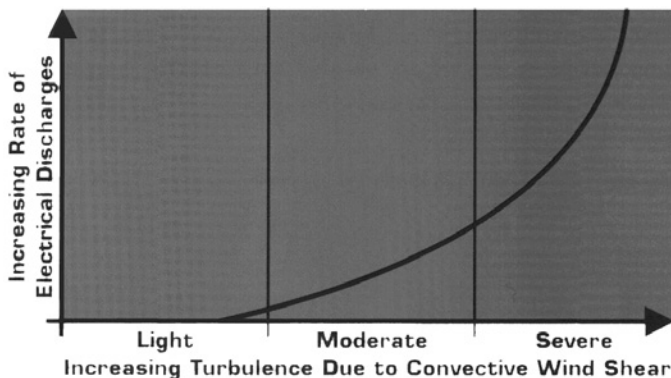

Figure 13-3 - Discharge Rate a Function of Wind Shear

STAGES OF A THUNDERSTORM

All thunderstorms begin as cumulus clouds, build to an intense mature stage, and finally dissipate. Each of these stages in the life of a thunderstorm present a different set of dangers to aircraft. Your Stormscope® system maps all stages in the life of a thunderstorm so that you won't be caught unaware by a thunderstorm that can build, mature, and dissipate in as little as 20 minutes.

Cumulus Stage

The cumulus or beginning stage of a thunderstorm is usually precipitation free. In this stage, the risks to an aircraft and its occupants include strong vertical winds, severe turbulence, icing and convective wind shear.

Mature Stage

In the mature and most intense stage of a thunderstorm, the water droplets within the cloud collide and combine to form rain and hail and, at cooler temperatures, sleet and snow. This stage poses many hazards to aircraft including heavy precipitation, high winds, convective wind shear, severe turbulence, downbursts, hail, icing, tornadoes, and lightning.

Dissipating Stage

In the dissipating stage, the updraft weakens and at the same time, the convective wind shear and other hazardous conditions begin to subside. There may be high rainfall rates in this stage, but the severe dangers are diminishing.

THE WX-500 AND WEATHER RADAR

The storm mapping technology used in the WX-500 system is fundamentally different than the technology used in weather radar. Weather radar operates by transmitting UHF radio waves in the direction of interest and then receiving echoes from water droplets, whereas the WX-500 operates by receiving signals already present in the atmosphere due to electrical discharges. The WX-500 analyzes the unique characteristics of these signals, their signal strength, and their varying rates of recurrence to determine the location and intensity of the thunderstorms that generated the discharges. The WX-500 can receive radiated electromagnetic signals from electrical discharges up to 200 nm away.

The cumulus stage of a thunderstorm (usually precipitation free) is unlikely to appear on weather radar; however, it generally does contain electrical discharges that will be detected by the WX-500 and will appear on the KMD 150's Stormscope® display as a light but increasing cluster of discharge points.

The WX-500 is not subject to attenuation. Weather radar, however, is subject to attenuation and may not see the "storm behind the storm" or may understate its intensity. With the WX-500, electrical discharges are mapped throughout the storm area. The size of the cluster of discharge points displayed on your KMD 150 Stormscope® screen indicates the size of the storm area. The speed with which the discharge points appear indicate the intensity of the storm regardless of the size of the cluster. The more intense the storm, the faster the discharge points appear.

OPERATION

As mentioned earlier, the WX-500 is controlled through the KMD 150. The focus on this section is to provide both background information and a more detailed explanation of the operating procedures. The following text assumes you have both the WX-500 and the KMD 150 switched on and that you have selected the Stormscope® screen from the main menu on the KMD 150.

POWER-UP

At power-up, the WX-500 executes a power-up self test. The self test takes approximately 25 seconds to ensure that all major WX-500 functions are operating properly. During this period you may receive a 'NO STORMSCOPE DATA' message, this is normal. Functions tested include antenna reception, memory and microprocessor functions. An error message is displayed if a fault is detected. Refer to the section on error messages later in this section for more information.

CONTINUOUS AND OPERATOR-INITIATED SELF TEST

In addition to the power-up self test, the WX-500 performs a continuous self test. Items tested include antenna operation, microprocessor functions, memory and heading inputs. This continuous self test is performed several times each minute. There are also provisions for an installer-initiated self test that can be executed through the Stormscope® setup screen.

HEADING STABILIZATION

The heading stabilization feature automatically adjusts the position of the discharge points on the display when your aircraft changes heading. Heading information may come from one of two sources. Firstly, you may have a remote heading source installed in your aircraft that has been connected to the WX-500. If this heading information is installed and is valid, the WX-500 and KMD 150 will use it. In the absence of an external heading reference, the KMD 150 will use GPS track to adjust the position of the discharge points on the display during turns and thereby keep all discharge points in the proper location relative to the nose of the aircraft.

NOTE:

GPS track is only available if you are moving in excess of 3 knots.

CLEAR ALL DISCHARGE POINTS

Clearing the discharge points periodically while you are monitoring thunderstorms is a good way to determine if the storm is building or dissipating. Discharge points in a building storm will reappear faster and in larger numbers. Discharge points in a dissipating storm will appear slower and in smaller numbers. To clear the discharge points, press the CLEAR key on the KMD 150. Alternatively, if an optional remote clear button has been fitted, press that.

SWITCH BETWEEN WEATHER VIEWS

The KMD 150 can display the Stormscope® data in one of two views, either all round (360°) or forward looking only (120°). To switch the display between weather views simply move the joystick up and down. Note that when switching between weather views, the range remains constant.

SWITCH BETWEEN WX DISPLAY MODES

As detailed in the introduction to this section, the KMD 150 can display the Stormscope® data in one of two modes, either Cell Mode or Strike Mode. To switch the display between modes simply move the joystick left and right. The currently selected weather display mode is indicated on the top left of the screen and will toggle between CELL and STRIKE with each press of the joystick. The mode selected here will remain in effect until you change it, even if the unit is turned off and back on.

CHANGING DISPLAY RANGE

To change the displayed range of the Stormscope® screen, press either the Zoom In or the Zoom Out keys. With each press of the zoom keys, the screen changes to display the electrical discharge activity detected within the new range. The range indicator will also change to display the numerical value of the new range (25, 50, 100, or 200 nm). This new range corresponds to the distance from the aircraft to the outer range ring on the screen.

Your KMD 150 stores electrical discharge information for all ranges simultaneously to provide you with an instant, up-to-date display of electrical discharge activity when you select a new range.

As you move from one range to the next, the 25 nm range is always indicated by a solid ring to advise you of your close proximity to thunderstorms. You may also notice that the discharge points are progressively larger on the shorter ranges and smaller on the longer ranges. This effect makes it easier to spot clusters of discharge points in any range.

OPERATION IN STORMSCOPE® MODE WITH NAV OVERLAY

If you are running a Flight Plan or have performed a DIRECT TO, the Flight Plan lines and waypoints will be displayed on the Stormscope® screens in the form of an overlay.

NOTE:

In order to align the lightning strikes correctly to the flight plan lines, heading information is necessary.

Heading information is available in the form of an external heading reference input (described previously) or in the form of GPS track data. If you do not have an external heading reference connected to your WX-500 Stormscope® unit, heading data will only be available from the GPS at ground speeds in excess of 3 knots.

If no external heading reference is connected and you are not moving, a message saying 'FLIGHT PLAN NOT PLOTTED, NO HEADING' will be displayed on the Stormscope® screen. This will be removed as soon as you start moving and the Nav overlay will be displayed.

OPERATION IN MAP MODE

The majority of the text in this section refers to the dedicated Stormscope® screens on the KMD 150. It is also possible however to see thunderstorm cell or strike data while in Map Mode, if you select the lightning icons to be shown (refer to the Map Setup screens). When lightning is first plotted on the map, a LIGHTNING message will be given at the bottom of the screen.

NOTE:

Lightning data will only be displayed on the map if a heading reference is available in the form of an external heading reference input (described previously) or in the form of GPS track data. If you do not have an external heading reference connected to your WX-500 Stormscope® unit, track data will only be available from the GPS at ground speeds in excess of 3 knots.

If no external heading reference is connected and you are not moving, a message saying 'LIGHTNING NOT PLOTTED, NO HEADING' will be displayed on the map screen. This will be removed as soon as you start moving and new lightning strikes will be displayed.

Any settings you make while in the dedicated Stormscope® screens (i.e. range, cell/strike mode, clear etc) will be carried over into Map Mode.

ERROR MESSAGES

The WX-500 detects most common faults and sends error messages to the KMD 150 indicating the nature of the faults and which functions may be inoperative. These error messages enable your authorized Stormscope® dealer or L-3 Communications factory service personnel to quickly diagnose and correct the fault. Table 13-1 lists all the possible error messages, the probable causes, and the recommended actions.

Error Message	Fault Source	Type*	Recommended Action
Error 01 Processor Fault	Main processor	F	Turn off the WX-500 and see your dealer for service.
Errors 05 thru 08 Processor Fault	Main Processor memory	F	Turn off the WX-500 and see your dealer for service.
Errors 09 thru 12 Processor Fault	DSP memory	F	Turn off the WX-500 and see you dealer for service.
Errors 14 and 15 Processor Fault	DSP	F	Turn off the WX-500 and see your dealer for service
Error 16 Antenna Fault	Antenna is not able to receive or forward the necessary thunderstorm data or it could be a faulty connection	NF/R	Continue without weather mapping functions. See your dealer for service.
Error 17 Processor Fault	No test strikes**	NF/R	Continue without weather mapping functions. See your dealer for service if this error occurs frequently.
Error 18 Processor Fault	Invalid test strike	NF/R	Continue without weather mapping functions. See your dealer for service if this error occurs frequently.
Error 19 Processor Fault	Main Processor data overload	NF/R	Continue without weather mapping functions. See your dealer for service if this error occurs frequently.
Error 20 Configuration Changed	Antenna jumper configuration changed since last time power was applied to the system.	NF/R	Check Antenna Location on the Stormscope setup screen. If jumper does not agree with user selection, "Configuration Fault" is displayed and continued operation is not possible.
Error 21 Processor Fault	Main processor	F	Turn off the WX-500 and see your dealer for service.
Error 22 Invalid Synchro Signals	Invalid XYZ input (gyro may still be spinning up)	NF/R	Continue without external heading stabilization. See your dealer for service.
Error 23 Invalid Synchro Ref	No 400 Hz reference	NF/R	Continue without external heading stabilization. See your dealer for service.
Error 24 Mic Key Stuck	Mic key (inhibit line) stuck. The microphone key has been depressed for more than 1 minute.	NF/R	Check your microphone key to correct the problem. If not correctable, continue without weather mapping functions and see your dealer for service.
Errors 25 thru 34 Software Error	Main processor	F	Turn off the unit and see your dealer for service.
Errors 35 and 36 Processor Fault	DSP or main processor	NF/R	Continue without weather mapping functions. See your dealer for service.
Error 40 Processor Fault	Main processor	NF/R	See your dealer for service if this error occurs frequently.
Error 41 Processor Fault	DSP or main processor	F	Turn off the WX-500 and see your dealer for service.
Error 42 Processor Fault	Main processor	F	Turn off the WX-500 and see your dealer for service.
Error 43 Invalid Request	KMD 150	NF/R	See your dealer for service if this error occurs frequently.
Error 44 thru 49 Serial Communications	KMD 150	NF/R	See your dealer for service if this error occurs frequently.
Error 50 Illegal Heading Value	KMD 150	NF/R	See your dealer for service if this error occurs frequently.
Error 51 Invalid Message	KMD 150	NF/R	See your dealer for service if this error occurs frequently.

*F=Fatal, NF=Non Fatal, R=Recoverable, NR=Non-Recoverable

Table 13-1 - Error Messages

If the KMD 150 receives an error message, an ERROR warning message will be displayed at the top of the Stormscope® screen followed by an error number.

If you receive one of these error warnings, make a note of the error number and report it to your authorized Stormscope® dealer as soon as possible.

Non-Fatal Faults

If a non-fatal fault occurs, all functions not directly affected by the fault will continue to operate and the ERROR message will remain on screen. You should see your authorized Stormscope® dealer as soon as possible to correct the fault.

Recoverable Faults

A recoverable fault is one that allows the affected functions to automatically resume proper operation after the fault goes away. The error message will disappear within 10 seconds after the fault goes away. The following is an example of a recoverable fault.

Heading-Related Faults

During a heading fault, the KMD 150 will automatically revert to using GPS track information (assuming you are moving in excess of 3 knots) in lieu of the now failed heading information. The ERROR message will stay on screen until the heading fault clears.

Non-Recoverable Faults

A non-recoverable fault will allow you to continue operation, but without the function that is affected by the fault. The affected function will not resume proper operation until the system is turned off and repaired.

Fatal Faults

If a fatal fault occurs, all Stormscope® functions will cease to operate and the message "NO STORMSCOPE DATA" will appear. In this case, turn the WX-500 off and see your authorized Stormscope® dealer for service.

WEATHER DISPLAY INTERPRETATION

WARNING

The illustrations in this guide are only examples. Never use your WX-500 to attempt to penetrate a thunderstorm. The FAA Advisory Circular, Subject: Thunderstorms, and the Airman's Information Manual (AIM) recommend that you "avoid by at least 20 miles any thunderstorm identified as severe or giving an intense radar echo."

CAUTION

There are several atmospheric phenomena other than nearby thunderstorms that can cause isolated discharge points in the strike display mode. Clusters of two or more discharge points in the strike display mode however do indicate thunderstorm activity when they reappear after clearing the screen. Avoid the clusters and you'll avoid the thunderstorms. In the cell display mode, even a single discharge point may represent thunderstorm activity and should be avoided.

The KMD 150 is not certified to Technical Standard Order C110a. Actual depiction of lightning data presented on the KMD 150 may be less than that measured by the WX-500.

INTRODUCTION

The following examples are designed to help you relate the patterns of +'s or x's on the Stormscope® screen to the size and location of thunderstorms that may be near your aircraft.

A black and white grid in the examples represents the airspace around your aircraft. (See Figure 13-4.) Each square in the grid represents a 100 by 100 nm area. A circle represents the area being monitored by your Stormscope® system. Areas of gray or black indicate thunderstorms. The darker the area, the greater the rate of electrical discharge activity.

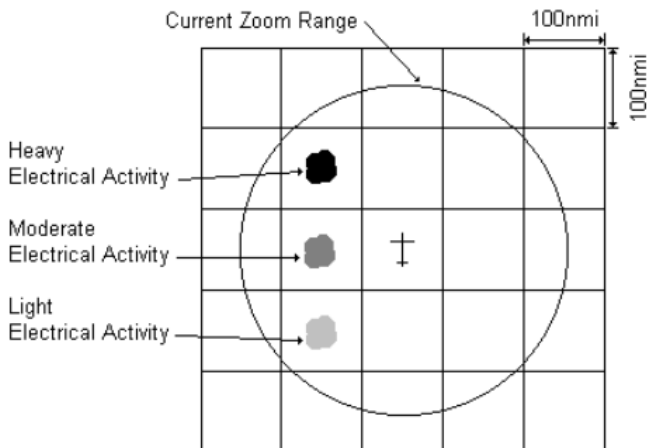

Figure 13-4 - Airspace Diagram

The WX-500 detects electrical discharges and sends them to the KMD 150 as storm cells or as independent strikes. The following examples include the KMD 150's Stormscope® screens in both the cell display mode and the strike display mode. When in map mode, if enabled, the cells and strikes will be displayed as lightning icons. To make a more detailed analysis of the storm, switch back to the dedicated Stormscope® screen.

RADIAL SPREAD

When the KMD 150 is in the strike display mode, it is common for a triangular-shaped stream of discharge points to appear between the aircraft symbol on the Stormscope® screen and a cluster of discharge points within the range of the WX-500. A similar stream of discharge points may appear radiating away from the aircraft symbol in the direction of possible thunderstorm activity beyond the range of the WX-500. These phenomena are examples of radial spread. Discharge points in radial spread do not necessarily indicate the exact location of atmospheric electrical discharges. To counteract radial spread, L3 Communications applied its extensive research in lightning detection to develop enhanced lightning positioning algorithms. These algorithms (used only in the cell display mode) greatly reduce radial spread and improve the depiction of thunderstorms on the display. The strike display mode does not use the enhanced lightning positioning algorithms; instead, it uses technology similar to that found in older Stormscope® systems and in competitor lightning detection systems.

TYPICAL PATTERNS

Three Clusters within the 200 nm Range Ring

Figure 13-5 shows the Stormscope® screen in the 360° weather view at the 200 nm range. Using this knowledge, the outer range ring, and the azimuth markers, the three clusters of discharge points on the left-hand Stormscope® screen (cell display mode) can be interpreted as representing three thunderstorm cells at the following azimuth and range:

<u>Cluster</u>	<u>Azimuth (clock position)</u>	<u>Range</u>
1	11:00	180 nm
2	4:00	75 nm
3	4:00	180 nm

Analysis of the right-hand Stormscope® screen (strike display mode) yields a similar, but less certain interpretation due to radial spread.

The Stormscope® screen can also tell us about the relative amount of electrical discharge activity in thunderstorm cells. Clusters 2 and 3 have more discharge points than cluster 1 indicating greater electrical discharge activity. All three clusters however must be avoided because you can't necessarily determine the severity of thunderstorms based strictly on the number of discharge points. For example, in the western United States, a severe thunderstorm may only have a few electrical discharges.

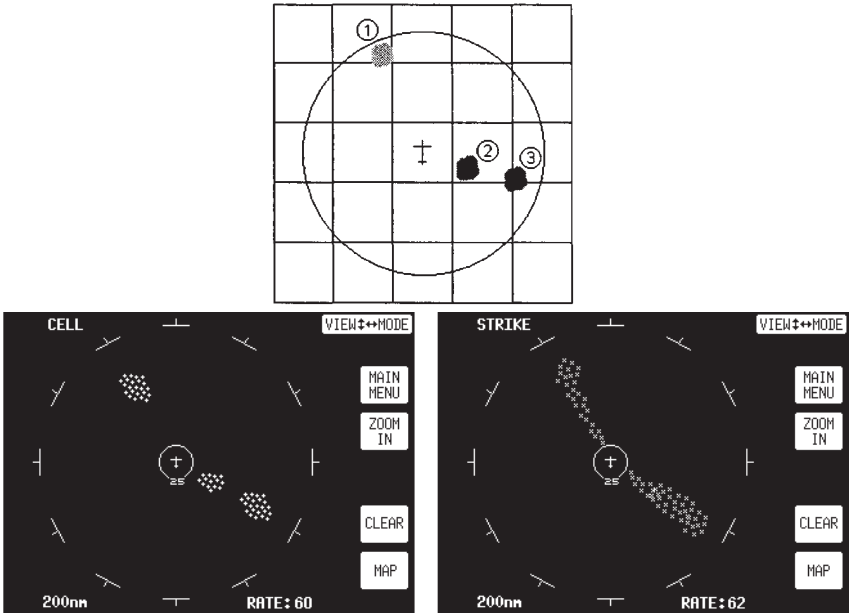

Figure 13-5 - Three Clusters Within 200 nm

Stormscope® Operation

When the Stormscope® range is changed to 100 nm (Figure 13-6), only cluster 2 remains visible. Clusters 1 and 3 are beyond the 100 nm range and therefore no longer appear on the screen. (Clusters 1 and 3 would again be visible if the range were returned to 200 nm.) Cluster 2 is now more defined and the discharge points are larger. The interpretation of cluster 2 remains the same: a moderately active thunderstorm at azimuth 4:00, range 75 nm. You'll notice on the right-hand Stormscope® screen (strike display mode) that there is less radial spread than there was in the 200 nm range. It is true in general that radial spread is reduced on the shorter ranges.

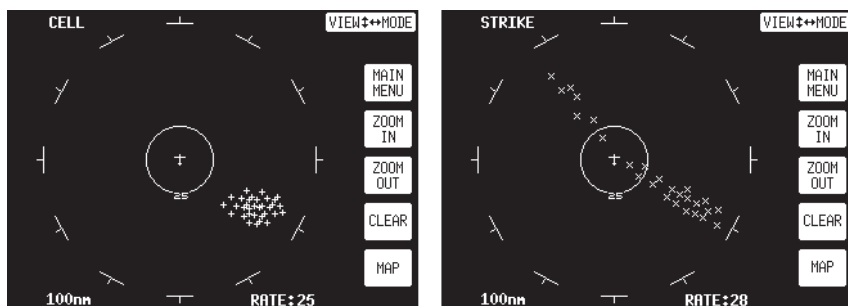
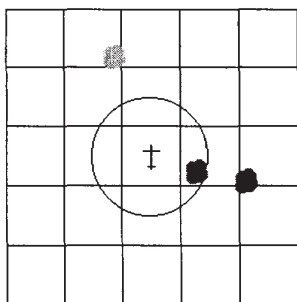

Figure 13-6 - Range Changed to 100 nm

Two Clusters within the 200 nm Range Ring

Figure 13-7 shows the Stormscope® screen in the 360° weather view at the 200 nm range. Using this knowledge, the outer range ring, and the azimuth markers, the two clusters of discharge points on the Stormscope® screen can be interpreted as representing one thunderstorm cell at 5:30, about 150 nm from the aircraft, and another thunderstorm cell at 1:00, about 100 nm from the aircraft. The cluster at 1:00 has less radial spread (in the strike display mode) and fewer discharge points than the cluster at 5:30 indicating a lower rate of electrical activity. Both clusters must be avoided.

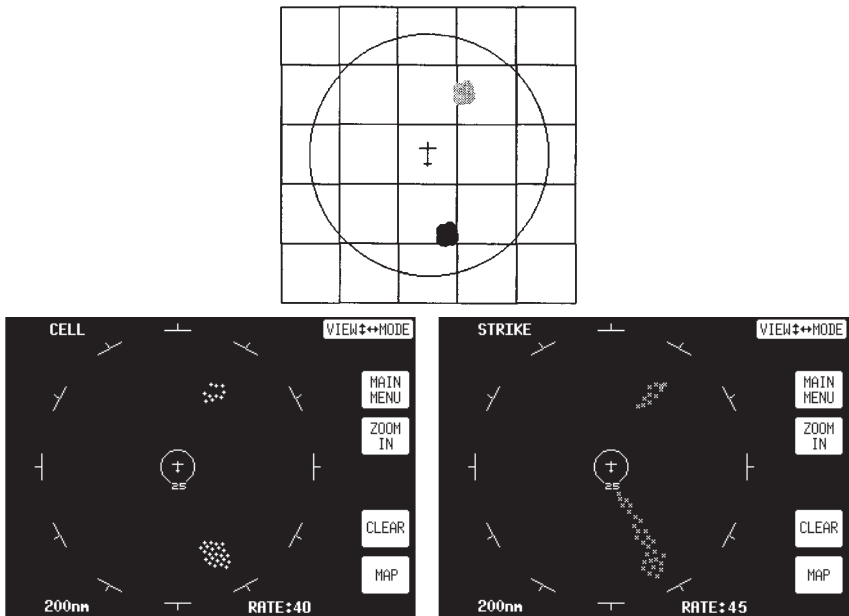

Figure 13-7 - Two Clusters Within 200 nm

MAPPING HEADINGS PAST THUNDERSTORMS

Figures 13-8 through 13-11 and the following paragraphs depict the progression of an aircraft past several thunderstorms.

Range Set at 200 nm

Figure 13-8 shows the Stormscope® screen in the 360° weather view at the 200 nm range. Two thunderstorms appear almost as one cluster of discharge points off the nose of the aircraft, centered 180 nm away. A second cluster at 9:30 indicates a storm system that contains three thunderstorms.

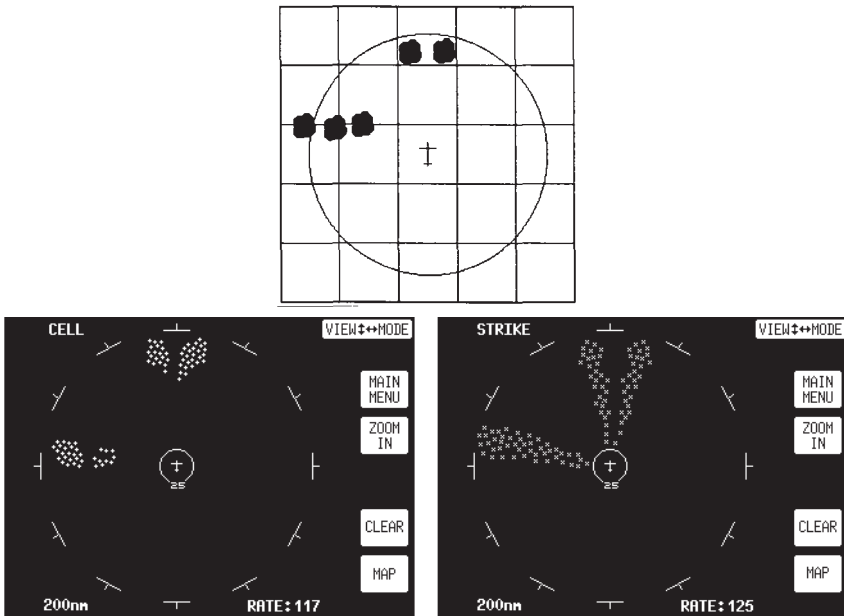

Figure 13-8 - Range Set at 200 nm

Aircraft Progresses 100 nm

Figure 13-9 shows that the aircraft has maintained its heading and progressed 100 nm. The two thunderstorms off the nose of the aircraft appear to have expanded horizontally on the screen. This effect is normal anytime you get closer to a storm. The line of thunderstorms previously at 9:30 now appears at 8:30.

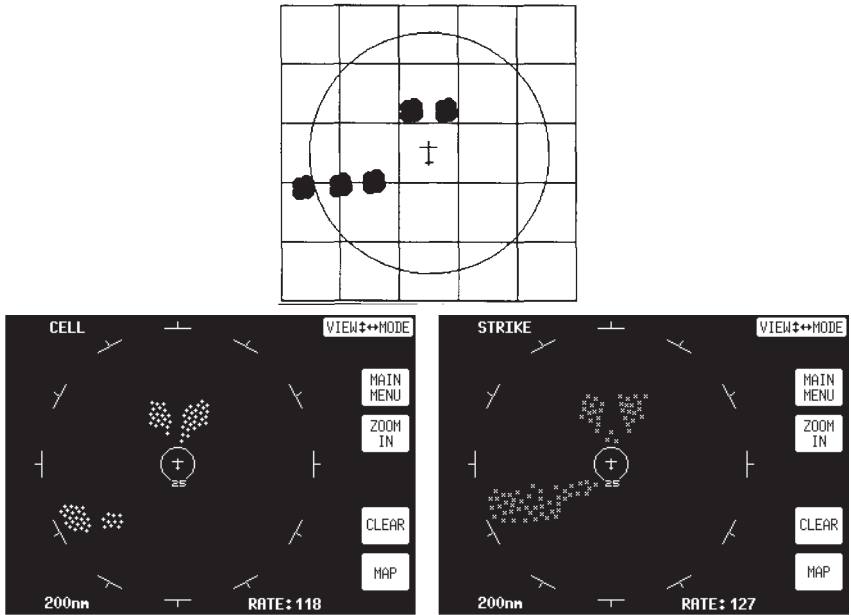

Figure 13-9 - Aircraft Progresses 100 nm

Range Changes to 100 nm

Figure 13-10 shows the Stormscope® screen a short time later in the 120° weather view at the 100 nm range. The thunderstorms at 8:30 are not visible in this view but the thunderstorms off the nose of the aircraft appear in greater detail as two separate thunderstorms. The thunderstorms at 11:30 and 12:15 are centered 90 nm from the aircraft. Information is now sufficient to map a Flight Plan around the thunderstorms. The WX-500 plots discharge points within the selected range even if the points obscure the CELL or STRIKE display mode indicator as they do in Figure 13-10.

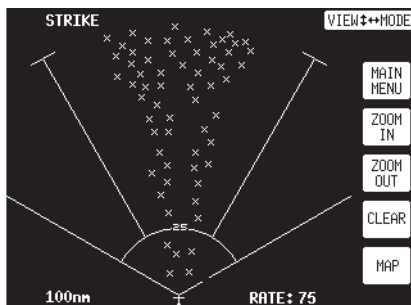
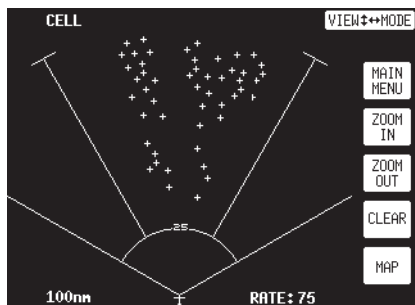
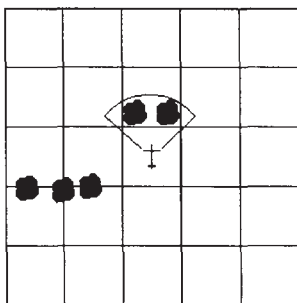

Figure 13-10 - Range Changes to 100 nm

Aircraft Turns to Avoid Thunderstorms

Figure 13-11 shows the Stormscope® screen a short time later after the aircraft has turned to the right to avoid the thunderstorms. When connected to a compatible heading system, the Stormscope® system automatically rotates the existing discharge points to their correct position relative to the new heading.

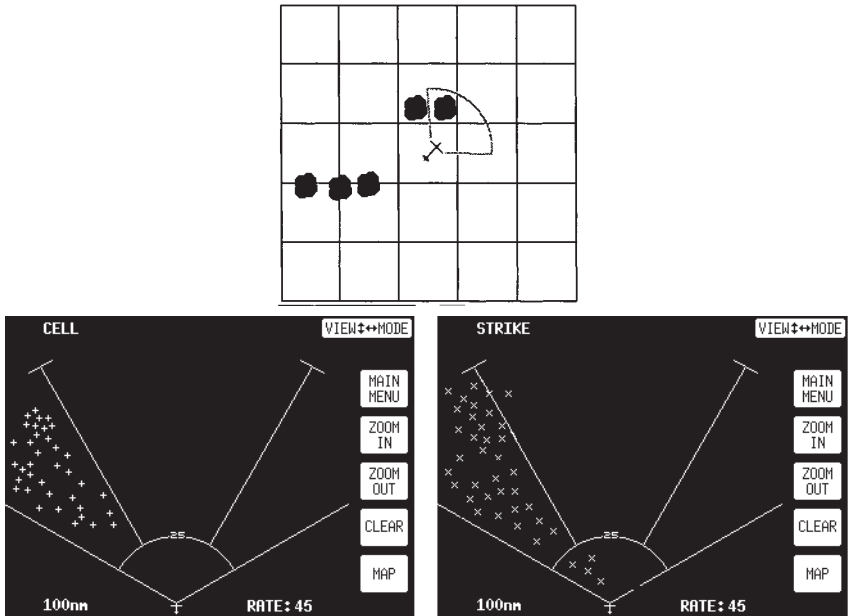

Figure 13-11 - Aircraft Turns To Avoid Thunderstorms

SPECIAL PATTERNS

Randomly Scattered Discharge Points

Atmospheric instability associated with cumulus clouds, or developing or dissipating thunderstorms could cause randomly scattered discharge points on the Stormscope® screen as shown in Figure 13-12. Random discharge points are more likely to appear in the Stormscope® system's strike display mode than in the cell display mode due to the cell display mode's clustering algorithm. If you observe random discharge points, continue to monitor the screen for developing clusters that indicate thunderstorm activity.

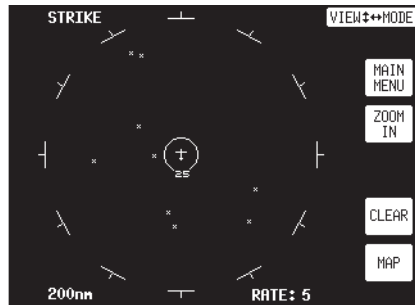
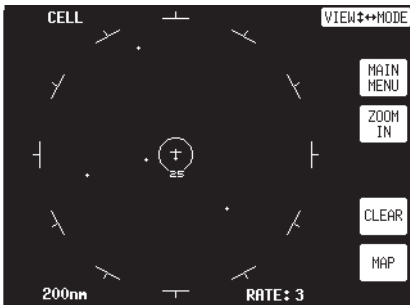
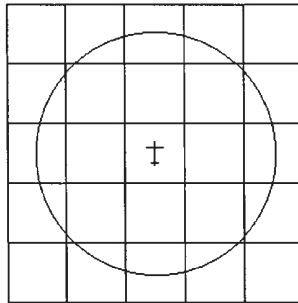

Figure 13-12 - Randomly Scattered Discharge Points

Cluster and Splattering Within 25 nm

Figure 13-13 shows the Stormscope® screen in the 360° weather view at the 25 nm range. One moderately active thunderstorm appears as a cluster of discharge points at 8:30 centered 14 nm away with a splattering of discharge points throughout the 25 nm range. Such splattering is due to electrical discharges within 3 to 5 nm of the aircraft and indicates that the aircraft is too close to the thunderstorm.

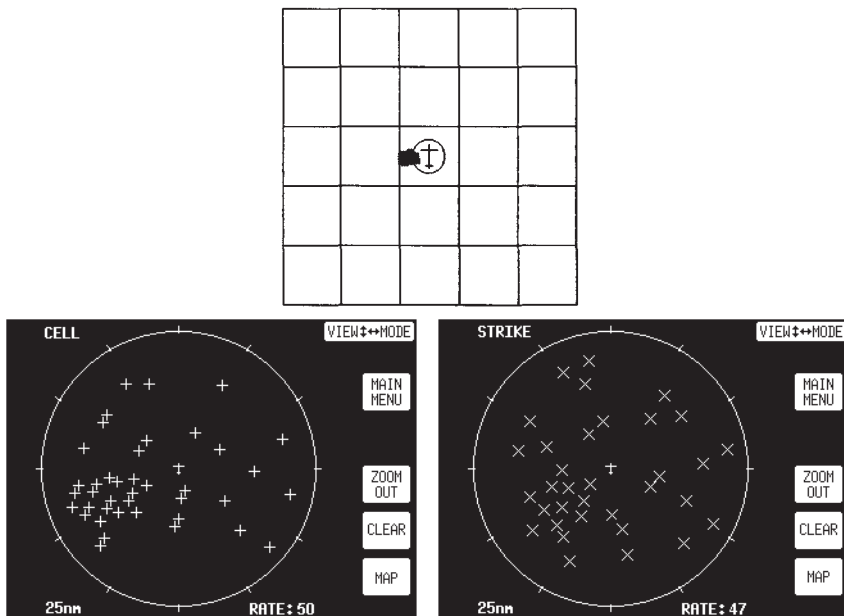

Figure 13-13 - Cluster and Splattering Within 25 nm

Continue to head away from the main cluster. While the main cluster should be your primary concern, you should also avoid any grouping of discharge points within the 25 nm range. Switch to the other range settings to ensure that there is no thunderstorm activity indicated along your intended path.

You'll notice in Figure 13-13 that the location of random, individual discharge points is about the same on both the cell and storm display modes. This is true because in the cell display mode, the Stormscope® system plots every electrical discharge detected within the 25 nm range at the exact location detected unless the discharge is associated with a cluster of discharges, in which case the discharge point is clustered with the associated discharge points. You'll also notice that there are more points in the cluster of points at 8:30 in the cell display mode than there are in the strike display mode. This is due to the cell display mode's clustering algorithm "pulling in" individual discharge points associated with the cluster.

Discharge Points Off Aircraft's Nose

Figure 13-14 shows the Stormscope® screen in the 360° weather view at the 200 nm range. The discharge points ahead of the aircraft could be caused by a strong thunderstorm just beyond the 200 nm range. Another scenario might be that electrical discharge signals are arriving via atmospheric skip from a distant thunderstorm well beyond the Stormscope® range. In either case, no immediate action is required.

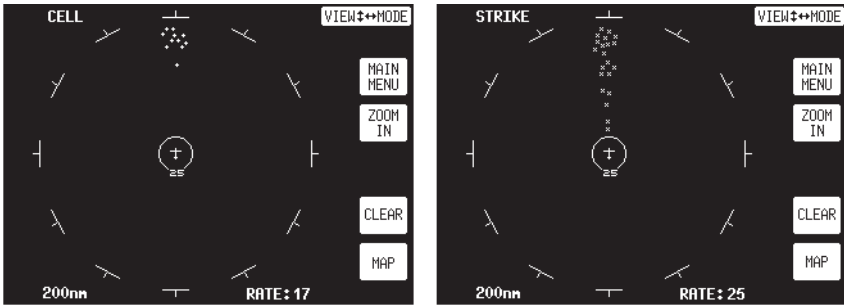
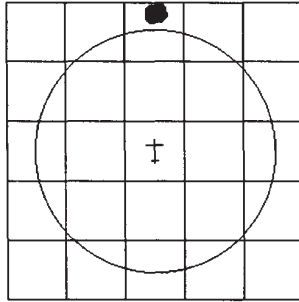

Figure 13-14 - Discharge Points Off Aircraft's Nose

Line of Discharge Points While Taxiing

Passing over a cable beneath the taxiway can cause a line of discharge points across the screen as shown in Figure 13-15. Similar concentrations of discharge points across the screen may appear while taxiing due to electrical signals from nearby equipment such as arc welders or subway rails. After passing the source of the interference, press the CLR button.

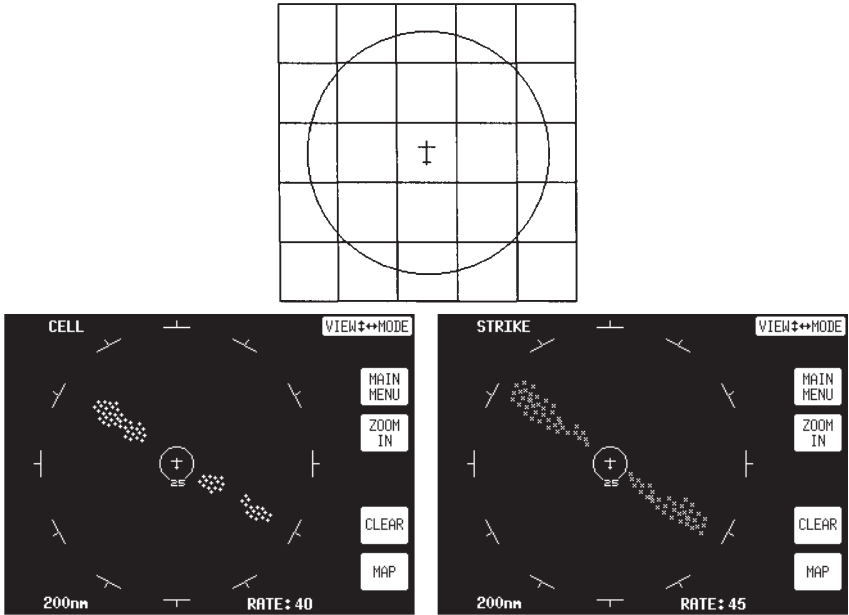

Figure 13-15 - Line of Discharge Points While Taxiing

Developing Cluster Within the 25 nm Range Ring

Figure 13-16 shows a developing thunderstorm 12 nm from the aircraft. If you see a screen such as this with a developing cluster within the 25 nm range ring, you should change course to avoid the storm and continue to monitor the Stormscope® screen.

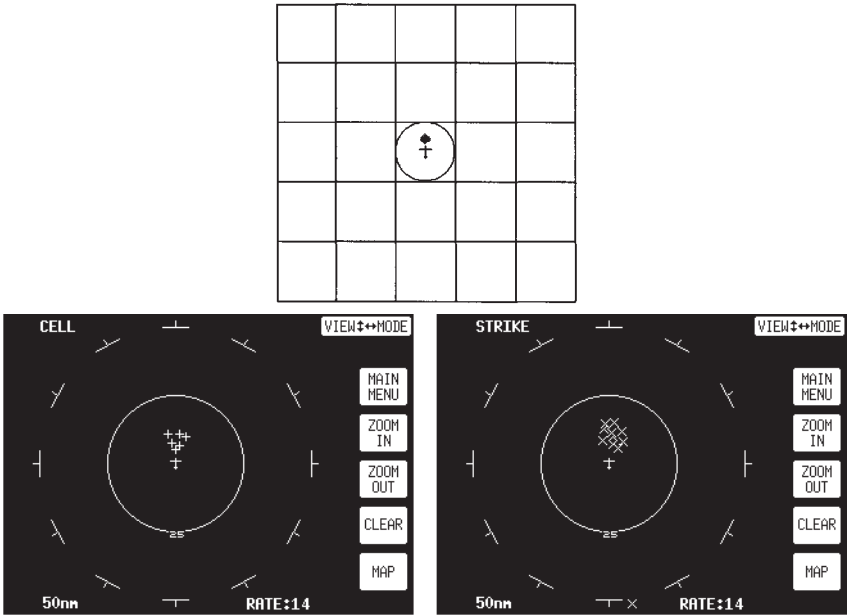
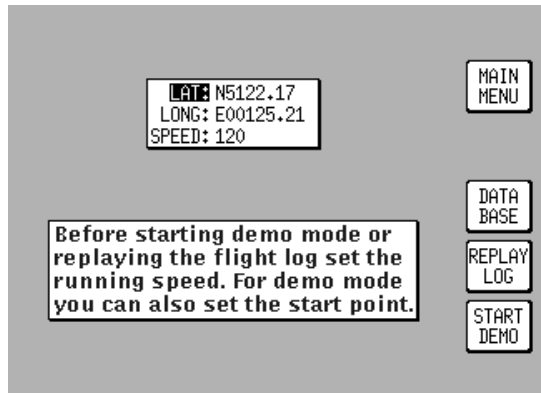

Figure 13-16 - Developing Cluster Within 25 nm Range Ring

DEMO MODE

Demo Mode is only available for those units with an internal GPS selected as the GPS Source.

To allow you to practice all aspects of navigation on the ground and to become familiar with handling it, your unit can be used as a simulator by selecting its fully functioning Demo Mode. Using this mode you can also replay your logged flight data.



Screen 20: Demo Mode Setup Screen

This Demo Mode Screen can be accessed by pressing Key 3, DEMO MODE, on Screen 1, Title Screen, provided that, since the time you switched it on, your KMD 150 has not received valid satellite information from its internal GPS receiver.

When you enter Demo Mode you will find a cursor over the word LAT. You can then use the joystick to set up the latitude and longitude for any point from which you want the demo to start. (The default latitude and longitude will be the co-ordinates of your last fix position.) Alternatively you can press Key 3 and select a start point from the built in database. You can also set the airspeed at which you want to fly the demo to anything between 000 and 999 Knots.

Once you have set your position and speed, if you press Key 5 you will find Screen 38, Map Mode, displayed and you are ready to start Demo Mode. All map Screens that you access while Demo Mode is switched on will, for safety reasons, have a DEMO MODE warning box displayed to ensure you do not use them while in the air.

If you wish to replay the flight data logged into your unit, set the airspeed as explained previously then press Key 4. Screen 50 will then be displayed with the logged data being replayed at the specified speed. This allows long flight plans to be replayed in fast motion.

WARNING:

In the interest of safety, Demo Mode will be automatically cancelled if the KMD 150 receives valid fix information from the internal GPS.

Demo Mode

In order to run Demo Mode for any length of time, it will be necessary to park the aircraft in a hanger where the internal GPS receiver can not receive a signal.

If Demo Mode is active and you switch to Screen 2, Main Menu Screen, you will see Key 3 is now labeled DEMO OFF and can be used to cancel Demo Mode.

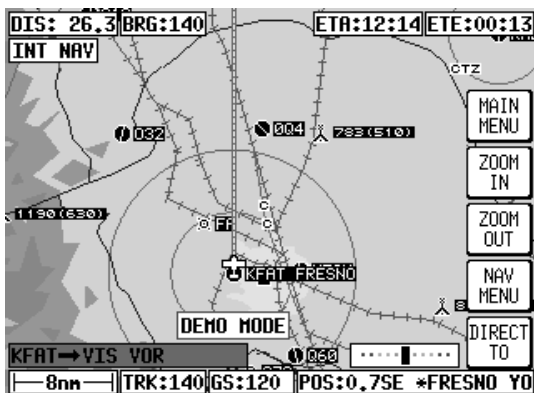

**Screen 50: Representation of Screen 47
Showing DEMO MODE Flag**

STORMSCOPE® DEMO MODE

If you have a WX-50 Stormscope® sensor connected to your KMD 150, entering Demo Mode on the KMD 150 will also cause the WX-50 to enter Demo Mode. When in Demo Mode, the WX-50 will output random storm patterns which will be received and interpreted by the KMD 150 in the normal way. See STORMSCOPE OPERATION for further details on the WX-50 interface option.

APPENDIX 1 - WARNING SCREENS

RAM LOST WARNING

This screen is displayed after power-on if any of the RAM areas are found to be corrupted. Key 1 causes a RAM clear to be carried out on the failed area and the last known good values to be reinstated. If the last known good values are also suspect, a full RAM clear of the affected data will be carried out.

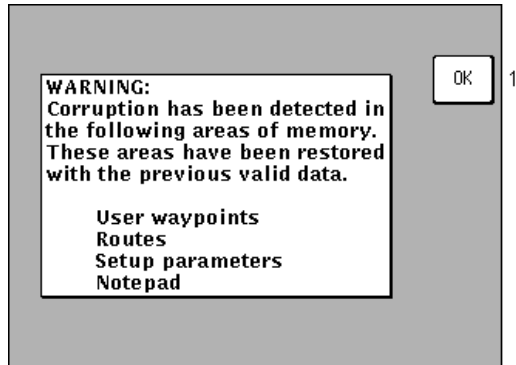

Screen 51: RAM Lost Warning Screen

MEMORY BATTERY WARNING

This Screen will appear if during initialization the memory battery voltage is found to be low. It can also appear at any time during operation if the internal battery falls below a pre-determined limit.

By pressing Key 1 you can return to whichever Screen was showing before the low voltage condition was detected. If this screen is displayed,

you should have your memory battery replaced by your Bendix/King dealer at the earliest possible opportunity.

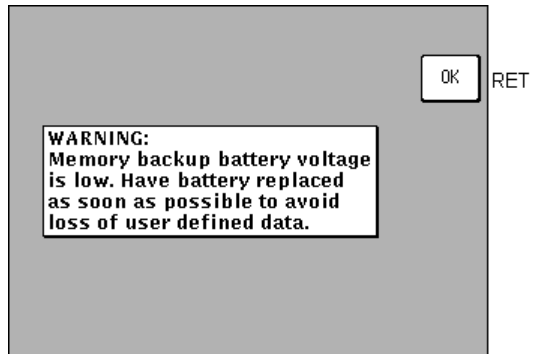

Screen 52: Memory Battery Warning Screen

PIN LOCK WARNING

If the Auto Power-On Lock function has been activated on Screen 26, this Screen will be called during initialization. You must then input the correct PIN before you are allowed to move back to Screen 1 with full access to all functions.

If an incorrect PIN is entered, Screen 25 will appear and Key 1 will revert to this Screen. If an

incorrect PIN is entered on three consecutive attempts, even if the unit has been switched off and back on again between attempts, Screen 55 will appear. The number of incorrect attempts that have been made is stored in NVM and increased with each incorrect attempt or cleared down once you have managed to enter the correct PIN.

As the PIN is entered, asterisk characters are displayed in place of the question marks. Key 1 can be used as a Back-Space Key.

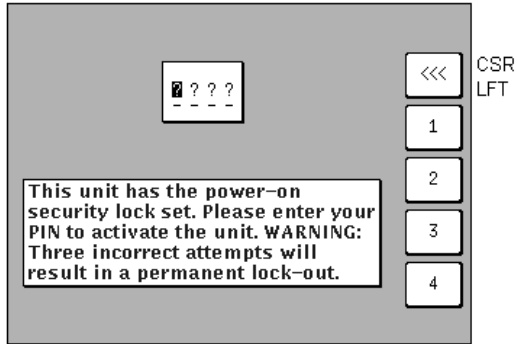

Screen 54: Power On Security PIN Entry Screen

LOCK OUT WARNING

This Screen will only appear after three incorrect PIN's have been entered on Screen 54 (or if when you switch the unit on the NVM is found to have accumulated three unsuccessful PIN input attempts).

The LOCK OUT number is a random five digit number that the unit generates. This is held in

RAM and does not change until an unlock number is entered. The unit can be switched off and on with this Screen showing but the LOCK OUT number will remain the same.

If you get locked out of the unit, in order to re-activate the unit, you will need to telephone Honeywell or your local Bendix/King dealer (or

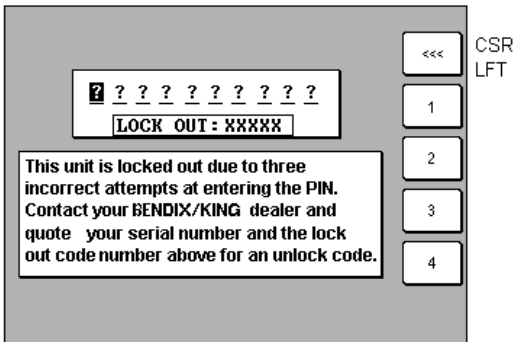

Screen 55: Lockout Screen

Skyforce Avionics Ltd. if in the United Kingdom) and provide them with your Serial Number and the Lockout Number. Your details will be verified and checked against a database and register of stolen units. Once the operator is satisfied that the unit has not been stolen and that you are the officially recognized owner, you will be given an Unlock Code Number.

This Unlock Code is a 10-digit number. You must enter this into your unit on Screen 55. The digits will replace the question marks as each one is entered. The Unlock Number is deemed to be entered as the last digit is input. Every time an incorrect unlock number is entered, the unit will generate a new LOCK OUT number. This makes it impossible for a would be thief to stumble upon the unlock number by trial and error. The chances of guessing the correct unlock code are 10 million to 1.

Once a lock out has occurred and the unit has been re-activated with an unlock number, the PIN will be reset to the default of 1234.

Be very careful if you activate the Auto Power On Lock feature. Locking yourself out of the system can be very inconvenient.

NEW DATABASE CARD WARNING

If, during initialization, the unit detects a new database card, the software will check through the Flight Plans programmed into the unit and validate the data.

Whenever you build a Flight Plan by using items from the database card, the Name, Lat. and Long of each chosen item is copied into RAM along with a note of which database and which country you extracted it. When a new database card is detected, each item in each Flight Plan is checked against the new database.

This is done by reading the first item from the first Flight Plan in RAM and conducting a search through the relevant part of the new database card looking for a Name match. If a perfect match is found for the Name, the Lat. and Long are then checked and if they match correctly also, then no action is required and the software goes on to check the next item.

If a discrepancy is found in either, Lat. or Long, Screen 56 will appear showing the new information for the User waypoint in question. You must confirm that you are aware of the change by pressing Key 1.

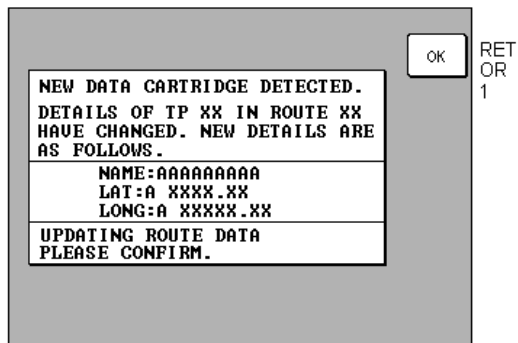

Screen 56: Flight Plan Change Warning Screen

Warning Screens

If no match can be found for the name (i.e. the name has been changed or the item has been deleted from the new database) the Lat. and Long fields on Screen 56 will be left blank and the bottom section of the box will read:

CHANGING DATABASE REFERENCE

PLEASE CONFIRM

Pressing Key 1 will change the database reference displayed on Screen 12, Flight Plan Program/Edit Screen, to OW indicating that this item is now an Old User Waypoint and is no longer accessible from any database.

This check is carried out for every point in every Flight Plan and whenever discrepancies are found, Screen 56 will appear on each occasion.

APPENDIX 2 - DATABASE CARDS

DATA AREAS

Honeywell produce three database cards based on the ICAO/ARINC geographic areas for KMD 150 that cover the entire world. Each card for each area contains the operating software, the appropriate Jeppesen aeronautical data, cartographic data and topological data to a high resolution. Also included is a low resolution map of the rest of the world.

The ten ICAO/ARINC areas along with their three letter identifiers are:

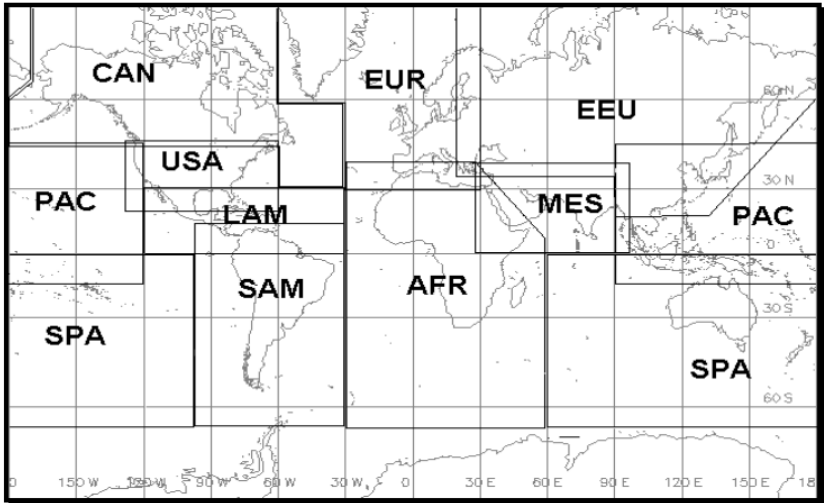

AFR Africa	CAN Canada	EEU Eastern Europe
EUR Europe	LAM Latin America	MES Middle East
PAC Pacific	SAM South America	SPA South Pacific
USA USA		

These areas are combined to produce three database cards covering the entire world that contain the following data:

AMR	Americas - comprising CAN, USA, LAM, SAM
ATI	Atlantic International - comprising EUR, AFR, EEU, MES
PAI	Pacific International - comprising PAC, SPA, EEU, MES

CHANGING THE DATABASE CARD

To change the database card follow these simple steps:

1. Switch your KMD 150 unit off.
2. Grasp the database card by its tag and pull it straight out of its socket.
3. Insert the new database card being careful to align the card with the socket then press the new card firmly into place.
4. Switch the unit on and check for correct operation. Screen 56 may be displayed if changes to information featured in your Flight Plans are detected. Please refer to the New Database Card Warning in Appendix 1.

MINIMUM SAFE ALTITUDES (MSA)

Included in the Jeppesen data supplied on your database card is Grid Minimum Off Route Altitude (Grid MORA) data. The correct use of this data is very important for terrain avoidance and hence requires some further explanation.

This data is split into a series of one degree squares tiles for the entire world. The Grid MORA provides reference point clearance within these tiles. Jeppesen define a reference point as a natural (peak, knoll, hill, etc) or man-made (tower, stack, tank, building, etc) object.

Jeppesen state that Grid MORA values clear all reference points by 1000 feet in areas where the highest reference points are 5000 feet MSL or lower. MORA values clear all reference points by 2000 feet in areas where the highest reference points are 5001 feet MSL or higher. Grid MORAs are defined for all areas.

In KMD 150 the Grid MORA information is used in two ways to derive Minimum Safe Altitudes (MSA), firstly during Flight Plan building and secondly during actual flight.

FLIGHT PLAN BUILDING

On screen 12, the Flight Plan Program / Edit Screen, as the cursor is moved up and down the Flight Plan, the MSA for that leg is shown in a box below the LEG and FPLN info box as [LEG MSA: XXXX]. This value is the highest value Grid MORA found along a ten mile wide corridor (including 5 miles past the waypoint) centered along each leg. Also shown is the [RTE MSA: XXXX] which is the highest value leg MSA for the entire Flight Plan.

DURING FLIGHT

An [MSA:XXXX] box is included on screen 41, the NAV Menu Screen. This displays the highest Grid MORA value within a ten mile radius of your present position at all times.

WARNING:

The MSA altitudes displayed are advisory in nature only. They should not be relied upon as the sole source of obstacle and terrain avoidance information. Always refer to current aeronautical charts for appropriate minimum clearance altitudes.

WORLD-WIDE ICAO CODES

In order to aid use of the KMD 150, especially the area filter used during database selection (Screens 16 and 16A), there follows a full list of all the countries and states that feature in the Jeppesen database along with their ICAO codes, Jeppesen standard name and the data area in which they are included (refer to the map at the beginning of this appendix).

Official Country/State Name	ICAO	Jeppesen Standard Name	State	Area
ACCRA FIR	DG	ACCRA FIR		AFR
ALGERIA, P. DEMOCRATIC REP OF	DA	ALGERIA	DZA	AFR
ANGOLA, REPUBLIC OF	FN	ANGOLA	AGO	AFR
ANTANANARIVO FIR/UIR	FM	ANTANANARIVO FIR/UIR		AFR
ANTARCTICA (AFR, INDIAN OC)	F1	ANTARCTICA (AFR)		AFR
ASCENSION I	FH	ASCENSION	SHN	AFR
BENIN, PEOPLES REPUBLIC OF	DB	BENIN	BEN	AFR
BOTSWANA, REPUBLIC OF	FB	BOTSWANA	BWA	AFR
BRAZZAVILLE FIR/UIR	FC	BRAZZAVILLE FIR/UIR		AFR
BRITISH INDIAN OCEAN TR.	FJ	BRITISH INDIAN OCEAN TR	IOT	AFR
BURKINA FASO	DF	BURKINA FASO	BFA	AFR
BURUNDI, REPUBLIC OF	HB	BURUNDI	BDI	AFR
CAMEROON, UNITED REPUBLIC OF	FK	CAMEROON	CMR	AFR
CANARY ISLANDS (SPAIN)	GC	CANARY IS	ESP	AFR
CAPE VERDE, REPUBLIC OF	GV	CAPE VERDE	CPV	AFR
CENTRAL AFRICAN REPUBLIC	FE	CENTRAL AFRICAN REP	CAF	AFR
CHAD, REPUBLIC OF	FT	CHAD	TCD	AFR
CHAGOS ARCHIPELAGO	FJ	CHAGOS ARCHIPELAGO	IOT	AFR
COMOROS, ISLAMIC FED REP OF	FM	COMOROS	COM	AFR
CONGO, REPUBLIC OF THE	FC	CONGO	COG	AFR
DAKAR FIR/UIR	GO	DAKAR FIR/UIR		AFR

Database Cards

DAKAR OCEANIC	GO	DAKAR OCEANIC	AFR
DAKHLA AND LAAYOUNE	GM	DAKHLA AND LAAYOUNE	AFR
DJIBOUTI, REPUBLIC OF	HD	DJIBOUTI	DJI AFR
EGYPT, ARAB REPUBLIC OF	HE	EGYPT	EGY AFR
EQUATORIAL GUINEA, REPUBLIC OF	FG	EQUATORIAL GUINEA	GNQ AFR
ERITREA	HH	ERITREA	ERI AFR
ETHIOPIA	HA	ETHIOPIA	ETH AFR
GABONESE REPUBLIC	FO	GABON	GAB AFR
GAMBIA, REPUBLIC OF THE	GB	GAMBIA	GMB AFR
GHANA, REPUBLIC OF	DG	GHANA	GHA AFR
GUINEA, REVOL PEOPLES REP OF	GU	GUINEA REP	GIN AFR
GUINEA-BISSAU, REPUBLIC OF	GG	GUINEA-BISSAU	GNB AFR
IVORY COAST, REPUBLIC OF	DI	IVORY COAST	CIV AFR
JOHANNESBURG FIR	FA	JOHANNESBURG FIR	AFR
KENYA, REPUBLIC OF	HK	KENYA	KEN AFR
LESOTHO, KINGDOM OF	FX	LESOTHO	LSO AFR
LIBERIA, REPUBLIC OF	GL	LIBERIA	LBR AFR
MALAGASCAR, REPUBLIC OF	FM	MADAGASCAR	MDG AFR
MALAWI, REPUBLIC OF	FW	MALAWI	MWI AFR
MALI, REPUBLIC OF	GA	MALI	MLI AFR
MAURITANIA, ISLAMIC REPUBLIC	GQ	MAURITANIA	MRT AFR
MAURITIUS FIR	FI	MAURITIUS FIR	AFR
MAYOTTE	FM	MAYOTTE	MYT AFR
MELILLA (SPAIN)	GE	MELILLA	ESP AFR
MOROCCO, KINGDOM OF	GM	MOROCCO	MAR AFR
MOZAMBIQUE, REPUBLIC OF	FQ	MOZAMBIQUE	MOZ AFR
N'DJAMENA FIR/UIR	FT	N'DJAMENA FIR/UIR	AFR
NAIROBI FIR	HK	NAIROBI FIR	AFR
NAMIBIA	FY	NAMIBIA	NAM AFR
NIAMEY FIR/UIR	DR	NIAMEY FIR/UIR	AFR
NIGER	DR	NIGER	NER AFR
NIGERIA, FEDERAL REPUBLIC OF	DN	NIGERIA	NGA AFR
REPUBLIC OF MAURITIUS	FI	MAURITIUS	MUS AFR
REUNION, DEPARTMENT OF	FM	REUNION	REU AFR
ROBERTS FIR	GL	ROBERTS FIR	AFR
RWANDESE REPUBLIC	HR	RWANDA	RWA AFR
SAINT HELENA	FH	ST HELENA	SHN AFR
SAL OCEANIC	GV	SAL OCEANIC	AFR
SAO TOME & PRINCIPE, DEM REP	FP	SAO TOME AND PRINCIPE	STP AFR
SENEGAL, REPUBLIC OF	GO	SENEGAL	SEN AFR
SEYCHELLES FIR	FS	SEYCHELLES FIR	AFR

SEYCHELLES, REPUBLIC OF	FS	SEYCHELLES	SYC	AFR
SIERRA LEONE, REPUBLIC OF	GF	SIERRA LEONE	SLE	AFR
SOC PEO LIBYAN ARAB JAMAHIRIYA	HL	LIBYA, SPA JAMAHIRIYA	LBY	AFR
SOMALI DEMOCRATIC REPUBLIC	HC	SOMALIA	SOM	AFR
SOUTH AFRICA, REPUBLIC OF	FA	SOUTH AFRICAN REP	ZAF	AFR
SUDAN, REPUBLIC OF THE	HS	SUDAN	SDN	AFR
SWAZILAND, KINGDOM OF	FD	SWAZILAND	SWZ	AFR
TANZANIA, UNITED REPUBLIC OF	HT	TANZANIA	TZA	AFR
TOGOLESE REPUBLIC	DX	TOGO	TGO	AFR
TUNISIA, REPUBLIC OF	DT	TUNISIA	TUN	AFR
UGANDA, REPUBLIC OF	HU	UGANDA	UGA	AFR
ZAIRE, REPUBLIC OF	FZ	ZAIRE	ZAR	AFR
ZAMBIA, REPUBLIC OF	FL	ZAMBIA	ZMB	AFR
ZIMBABWE, REPUBLIC OF	FV	ZIMBABWE	ZWE	AFR

Official Country/State Name	ICAO	Jeppesen Standard Name	State	Area
ALASKA	PA	ALASKA	USA	CAN
ALBERTA	CY	ALBERTA	CAN	CAN
BRITISH COLUMBIA	CY	BRITISH COLUMBIA	CAN	CAN
CANADA	CY	CANADA	CAN	CAN
MANITOBA	CY	MANITOBA	CAN	CAN
NEW BRUNSWICK	CY	NEW BRUNSWICK	CAN	CAN
NEWFOUNDLAND	CY	NEWFOUNDLAND	CAN	CAN
NORTHWEST TERRITORIES	CY	NORTHWEST TERRITORIES	CAN	CAN
NOVA SCOTIA	CY	NOVA SCOTIA	CAN	CAN
ONTARIO	CY	ONTARIO	CAN	CAN
PRINCE EDWARD ISLAND	CY	PRINCE EDWARD ISLAND	CAN	CAN
QUEBEC	CY	QUEBEC	CAN	CAN
SAINT PIERRE AND MIQUELON	CF	ST PIERRE I	SPM	CAN
SAINT PIERRE AND MIQUELON	CF	MIQUELON I	SPM	CAN
SASKATCHEWAN	CY	SASKATCHEWAN	CAN	CAN
YUKON TERRITORY	CY	YUKON TERRITORY	CAN	CAN
ARMENIA, REPUBLIC OF	UG	ARMENIA	ARM	EEU
AZERBAIJANI REPUBLIC	UB	AZERBAIJAN	AZE	EEU
BELARUS, REPUBLIC OF	UM	BELARUS	BLR	EEU
BULGARIA, REPUBLIC OF	LB	BULGARIA	BGR	EEU
CHINA, PEOPLES REPUBLIC OF	ZB	CHINA, PR OF	CHN	EEU
CHINA, PEOPLES REPUBLIC OF	ZG	CHINA, PR OF	CHN	EEU
CHINA, PEOPLES REPUBLIC OF	ZL	CHINA, PR OF	CHN	EEU
CHINA, PEOPLES REPUBLIC OF	ZP	CHINA, PR OF	CHN	EEU

Database Cards

CHINA, PEOPLES REPUBLIC OF	ZU	CHINA, PR OF	CHN	EEU
CHINA, PEOPLES REPUBLIC OF	ZY	CHINA, PR OF	CHN	EEU
CHINA, PEOPLES REPUBLIC OF	ZW	CHINA, PR OF	CHN	EEU
CHINA, PEOPLES REPUBLIC OF	ZH	CHINA, PR OF	CHN	EEU
CHINA, PEOPLES REPUBLIC OF	ZS	CHINA, PR OF	CHN	EEU
CZECH REPUBLIC	LK	CZECH	CZE	EEU
GEORGIA, REPUBLIC OF	UG	GEORGIA	GEO	EEU
HUNGARIAN PEOPLE'S REPUBLIC	LH	HUNGARY	HUN	EEU
KAZAKHSTAN, REPUBLIC OF	UT	KAZAKHSTAN	KAZ	EEU
KAZAKHSTAN, REPUBLIC OF	UA	KAZAKHSTAN	KAZ	EEU
KAZAKHSTAN, REPUBLIC OF	UR	KAZAKHSTAN	KAZ	EEU
KOREA, DEMOCRAT PEOPLES REP OF	ZK	KOREA, DPR OF	PRK	EEU
KYRGYZ REPUBLIC	UA	KYRGYZSTAN	KGZ	EEU
LATVIA, REPUBLIC OF	EV	LATVIA	LVA	EEU
LITHUANIA, REPUBLIC OF	EY	LITHUANIA	LTU	EEU
MOLDOVA, REPUBLIC OF	LU	MOLDOVA	MDA	EEU
MONGOLIA	ZM	MONGOLIA	MNG	EEU
POLISH PEOPLES REPUBLIC	EP	POLAND	POL	EEU
REPUBLIC OF ESTONIA	EE	ESTONIA	EST	EEU
ROMANIA, SOCIALIST REPUBLIC OF	LR	ROMANIA	ROM	EEU
RUSSIAN FEDERATION	UN	RUSSIA	RUS	EEU
RUSSIAN FEDERATION	US	RUSSIA	RUS	EEU
RUSSIAN FEDERATION	UM	RUSSIA	RUS	EEU
RUSSIAN FEDERATION	UR	RUSSIA	RUS	EEU
RUSSIAN FEDERATION	UE	RUSSIA	RUS	EEU
RUSSIAN FEDERATION	UH	RUSSIA	RUS	EEU
RUSSIAN FEDERATION	UU	RUSSIA	RUS	EEU
RUSSIAN FEDERATION	UL	RUSSIA	RUS	EEU
RUSSIAN FEDERATION	UO	RUSSIA	RUS	EEU
RUSSIAN FEDERATION	UI	RUSSIA	RUS	EEU
RUSSIAN FEDERATION	UW	RUSSIA	RUS	EEU
SLOVAK REPUBLIC	LZ	SLOVAKIA	SVK	EEU
TAJIKISTAN, REPUBLIC OF	UT	TAJIKISTAN	TJK	EEU
TURKMENISTAN	UT	TURKMENISTAN	TKM	EEU
UKRAINE	UK	UKRAINE	UKR	EEU
UZBEKISTAN, REPUBLIC OF	UT	UZBEKISTAN	UZB	EEU

Official Country/State Name	ICAO	Jeppesen Standard Name	State	Area
ALBANIA, REPUBLIC OF	LA	ALBANIA	ALB	EUR
AUSTRIA, REPUBLIC OF	LO	AUSTRIA	AUT	EUR
AZORES (PORTUGAL)	LP	AZORES	PRT	EUR

BELGIUM	EB	BELGIUM	BEL	EUR
BOSNIA AND HERZEGOVINA, REP OF	LQ	BOSNIA AND HERZEGOVINA	BIH	EUR
CROATIA, REPUBLIC OF	LD	CROATIA	HRV	EUR
DENMARK	EK	DENMARK	DNK	EUR
FAROE ISLANDS (DENMARK)	EK	FAROE IS	FRO	EUR
FINLAND	EF	FINLAND	FIN	EUR
FRENCH REPUBLIC	LF	FRANCE	FRA	EUR
GERMANY, FEDERAL REPUBLIC OF	ET	GERMANY	DEU	EUR
GERMANY, FEDERAL REPUBLIC OF	ED	GERMANY	DEU	EUR
GIBRALTAR	LX	GIBRALTAR	GIB	EUR
GREECE (HELLENIC REPUBLIC)	LG	GREECE	GRC	EUR
GREENLAND	BG	GREENLAND	GRL	EUR
ICELAND, REPUBLIC OF	BI	ICELAND	ISL	EUR
IRELAND	EI	IRELAND	IRL	EUR
ITALIAN REPUBLIC	LI	ITALY	ITA	EUR
LUXEMBOURG, GRAND DUCHY OF	EL	LUXEMBOURG	LUX	EUR
MACEDONIA	LW	MACEDONIA	MKD	EUR
MADEIRA ISLANDS(PORTUGAL)	LP	MADEIRA IS	PRT	EUR
MALTA, REPUBLIC OF	LM	MALTA	MLT	EUR
NETHERLANDS	EH	NETHERLANDS	NLD	EUR
NORWAY	EN	NORWAY	NOR	EUR
PORTUGUESE REPUBLIC	LP	PORTUGAL	PRT	EUR
REPUBLIC OF SLOVENIA	LJ	SLOVENIA	SVN	EUR
SANTA MARIA OCEANIC	LP	SANTA MARIA OCEANIC		EUR
SHANWICK OCEANIC	EG	SHANWICK OCEANIC		EUR
SPANISH STATE	LE	SPAIN	ESP	EUR
SWEDEN, KINGDOM OF	ES	SWEDEN	SWE	EUR
SWISS CONFEDERATION	LS	SWITZERLAND	CHE	EUR
U. KINGDOM OF G.B. AND N. IRE.	EG	UNITED KINGDOM	GBR	EUR
YUGOSLAVIA, FED REP OF	LY	YUGOSLAVIA	YUG	EUR

Official Country/State Name	ICAO	Jeppesen Standard Name	State	Area
ANGUILLA	TQ	ANGUILLA	AIA	LAM
ANTIGUA AND BARBUDA	TA	ANTIGUA	ATG	LAM
ARUBA	TN	ARUBA	ANT	LAM
BARBADOS	TB	BARBADOS	BRB	LAM
BELIZE	MZ	BELIZE	BLZ	LAM
CAICOS ISLANDS	MB	CAICOS IS	TCA	LAM
CAYMAN ISLANDS	MW	CAYMAN IS	CYM	LAM
COSTA RICA, REPUBLIC OF	MR	COSTA RICA	CRI	LAM

Database Cards

CUBA, REPUBLIC OF	MU	CUBA	CUB	LAM
DOMINICA	TD	DOMINICA	DMA	LAM
DOMINICAN REPUBLIC	MD	DOMINICAN REPUBLIC	DOM	LAM
EL SALVADOR, REPUBLIC OF	MS	EL SALVADOR	SLV	LAM
GRENADA	TG	GRENADA	GRD	LAM
GUADELOUPE, DEPARTMENT OF	TF	GUADELOUPE	GLP	LAM
GUATEMALA, REPUBLIC OF	MG	GUATEMALA	GTM	LAM
HAITI, REPUBLIC OF	MT	HAITI	HTI	LAM
HONDURAS, REPUBLIC OF	MH	HONDURAS	HND	LAM
JAMAICA	MK	JAMAICA	JAM	LAM
MARTINIQUE	TF	MARTINIQUE	MTQ	LAM
MEXICO (UNITED MEXICAN STATES)	MM	MEXICO	MEX	LAM
MONTSERRAT	TR	MONTSERRAT I	MSR	LAM
NETHERLANDS ANTILLES	TN	NETH ANTILLES	ANT	LAM
NICARAGUA, REPUBLIC OF	MN	NICARAGUA	NIC	LAM
PANAMA, REPUBLIC OF	MP	PANAMA	PAN	LAM
PUERTO RICO	TJ	PUERTO RICO	PRI	LAM
SAINT KITTS AND NEVIS	TK	NEVIS I	KNA	LAM
SAINT VINCENT & THE GRENADINES	TV	ST VINCENT	VCT	LAM
SAINT LUCIA	TL	ST LUCIA	LCA	LAM
SAINT KITTS AND NEVIS	TK	ST KITTS	KNA	LAM
SAN ANDRES (COLOMBIA)	SK	SAN ANDRES	COL	LAM
TRINIDAD AND TOBAGO, REP OF	TT	TOBAGO I	TTO	LAM
TRINIDAD AND TOBAGO, REP OF	TT	TRINIDAD	TTO	LAM
TURKS AND CAICOS ISLANDS	MB	TURKS IS	TCA	LAM
VIRGIN ISLANDS OF THE U.S.	TI	VIRGIN IS	VIR	LAM
VIRGIN ISLANDS, BRITISH	TU	BRITISH VIRGIN IS	VGB	LAM

Official Country/State Name	ICAO	Jeppesen Standard Name	State	Area
AFGHANISTAN, ISLAMIC STATE OF	OA	AFGHANISTAN	AFG	MES
BAHRAIN FIR/UIR	OB	BAHRAIN FIR/UIR		MES
BAHRAIN, STATE OF	OB	BAHRAIN	BHR	MES
BANGLADESH	VG	BANGLADESH	BGD	MES
BHUTAN, KINGDOM OF	VQ	BHUTAN	BTN	MES
CYPRUS, REPUBLIC OF	LC	CYPRUS	CYP	MES
INDIA, REPUBLIC OF	VI	INDIA	IND	MES
INDIA, REPUBLIC OF	VE	INDIA	IND	MES
INDIA, REPUBLIC OF	VO	INDIA	IND	MES
INDIA, REPUBLIC OF	VA	INDIA	IND	MES
IRAN, ISLAMIC REPUBLIC OF	OI	IRAN	IRN	MES

IRAQ, REPUBLIC OF	OR	IRAQ	IRQ	MES
ISRAEL, STATE OF	LL	ISRAEL	ISR	MES
JEDDAH FIR	OE	JEDDAH FIR		MES
JERUSALEM	LL	JERUSALEM	ISR	MES
JORDAN, HASHEMITE KINGDOM OF	OJ	JORDAN	JOR	MES
KUWAIT, STATE OF	OK	KUWAIT	KWT	MES
LEBANESE REPUBLIC	OL	LEBANON	LBN	MES
MALDIVES	VR	MALDIVES	MDV	MES
NEPAL, KINGDOM OF	VN	NEPAL	NPL	MES
OMAN, SULTANATE OF	OO	OMAN	OMN	MES
PAKISTAN, ISLAMIC REPUBLIC OF	OP	PAKISTAN	PAK	MES
QATAR, STATE OF	OT	QATAR	QAT	MES
REPUBLIC OF YEMEN	OY	YEMEN	YEM	MES
SAUDI ARABIA, KINGDOM OF	OE	SAUDI ARABIA	SAU	MES
SRI LANKA, DEM SOC REP OF	VC	SRI LANKA	LKA	MES
SYRIAN ARAB REPUBLIC	OS	SYRIA	SYR	MES
TURKEY, REPUBLIC OF	LT	TURKEY	TUR	MES
TURKEY, REPUBLIC OF N CYPRUS	LC	TURKEY (REP OF N CYPRUS)	TUR	MES
UNITED ARAB EMIRATES	OM	UNITED ARAB EMIRATES	ARE	MES

Official Country/State Name	ICAO	Jeppesen Standard Name	State	Area
CAMBODIA, STATE OF	VD	CAMBODIA	KHM	PAC
CAROLINE ISLANDS	PT	CAROLINE IS	PCI	PAC
CHINA, THE REPUBLIC OF	RC	TAIWAN	TWN	PAC
GUAM	PG	GUAM	GUM	PAC
HAWAII	PH	HAWAII	USA	PAC
HONG KONG	VH	HONG KONG	HKG	PAC
JAPAN	RJ	JAPAN	JPN	PAC
JAPAN	RO	JAPAN	JPN	PAC
JOHNSTON ATOLL	PJ	JOHNSTON ATOLL	JTN	PAC
KIRIBATI	PC	KIRIBATI	KIR	PAC
KIRIBATI	PL	KIRIBATI	KIR	PAC
KOREA, REPUBLIC OF	RK	KOREA	KOR	PAC
LAO, PEOPLES DEM REP OF	VL	LAOS	LAO	PAC
MACAU	VM	MACAU	MAC	PAC
MARIANA ISLANDS	PG	MARIANA IS	MNP	PAC
MARSHALL ISLANDS	PK	MARSHALL IS	MHL	PAC
MICRONESIA, FED STATES OF	PT	MICRONESIA	FSM	PAC
MIDWAY ISLANDS	PM	MIDWAY I	MID	PAC
MYANMAR, UNION OF	VY	MYANMAR	MMR	PAC

Database Cards

NORTHERN MARIANA ISLANDS	PG	NORTHERN MARIANA IS	MNP	PAC
OAKLAND OCEANIC CONTROL AREA	P	OAKLAND OCTA	USA	PAC
PALAU, REPUBLIC OF	PT	PALAU	PLW	PAC
PHILIPPINES, REPUBLIC OF THE	RP	PHILIPPINES	PHL	PAC
THAILAND, KINGDOM OF	VT	THAILAND	THA	PAC
VIETNAM, SOCIALIST REP OF	VV	VIETNAM	VNM	PAC
WAKE ISLAND	PW	WAKE I	XJW	PAC

Official Country/State Name	ICAO	Jeppesen Standard Name	State	Area
ANTARCTICA (ARG, CHILE)	S1	ANTARCTICA (ARG, CHILE)		SAM
ARGENTINA, REPUBLIC OF	SA	ARGENTINA	ARG	SAM
BOLIVIA, REPUBLIC OF	SL	BOLIVIA	BOL	SAM
BRAZIL, FED. REPUBLIC OF	SB	BRAZIL	BRA	SAM
CHILE, REPUBLIC OF	SC	CHILE	CHL	SAM
COLOMBIA, REPUBLIC OF	SK	COLOMBIA	COL	SAM
ECUADOR	SE	ECUADOR	ECU	SAM
FALKLAND ISLANDS	SF	FALKLAND IS	FLK	SAM
FRENCH GUIANA	SO	FRENCH GUIANA	GUF	SAM
GUYANA, REPUBLIC OF	SY	GUYANA	GUY	SAM
PARAGUAY, REPUBLIC OF	SG	PARAGUAY	PRY	SAM
PERU, REPUBLIC OF	SP	PERU	PER	SAM
SURINAME, REPUBLIC OF	SM	SURINAME	SUR	SAM
URUGUAY, REPUBLIC OF	SU	URUGUAY	URY	SAM
VENEZUELA, REPUBLIC OF	SV	VENEZUELA	VEN	SAM

Official Country/State Name	ICAO	Jeppesen Standard Name	State	Area
ANTARCTICA (AUS,NZ)	A1	ANTARCTICA (AUS,NZ)		SPA
AUSTRALIA	YM	AUSTRALIA	AUS	SPA
AUSTRALIA	YS	AUSTRALIA	AUS	SPA
AUSTRALIA	YP	AUSTRALIA	AUS	SPA
AUSTRALIA	YB	AUSTRALIA	AUS	SPA
BRUNEI DARUSSALAM	WB	BRUNEI	BRN	SPA
COOK ISLANDS	NC	COOK IS	COK	SPA
EASTER ISLAND (CHILE)	SC	EASTER I	CHL	SPA
FIJI	NF	FIJI IS	FJI	SPA
FRENCH PACIFIC OVERSEAS TERR.	NT	FRENCH PACIFIC	PYF	SPA
INDONESIA, REPUBLIC OF	WA	INDONESIA	IDN	SPA
INDONESIA, REPUBLIC OF	WR	INDONESIA	IDN	SPA
INDONESIA, REPUBLIC OF	WP	INDONESIA	IDN	SPA
INDONESIA, REPUBLIC OF	WI	INDONESIA	IDN	SPA

KIRIBATI	NG	KIRIBATI	KIR	SPA
MALAYSIA	WM	MALAYSIA	MYS	SPA
MALAYSIA	WB	MALAYSIA	MYS	SPA
NAURU, REPUBLIC OF	AN	NAURU	NRU	SPA
NEW CALEDONIA	NW	NEW CALEDONIA	NCL	SPA
NEW ZEALAND	NZ	NEW ZEALAND	NZL	SPA
NIUE	NI	NIUE	NIU	SPA
PAPUA NEW GUINEA	AY	PAPUA NEW GUINEA	PNG	SPA
SAMOA, AMERICAN	NS	AMERICAN SAMOA	ASM	SPA
SAMOA, INDEP STATE OF WESTERN	NS	WESTERN SAMOA	WSM	SPA
SINGAPORE, REPUBLIC OF	WS	SINGAPORE	SGP	SPA
SOCIETY ISLANDS	NT	SOCIETY IS	PYF	SPA
SOLOMON ISLANDS	AG	SOLOMON IS	SLB	SPA
TONGA, KINGDOM OF	NF	TONGA	TON	SPA
TUAMOTU ISLANDS	NT	TUAMOTU IS	PYF	SPA
TUVALU	NG	TUVALU	TUV	SPA
VANUATU, REPUBLIC OF	NV	VANUATU	VUT	SPA
WALLIS AND FUTUNA ISLANDS	NL	FUTUNA IS	WLF	SPA
WALLIS AND FUTUNA ISLANDS	NL	WALLIS IS	WLF	SPA

Official Country/State Name	ICAO	Jeppesen Standard Name	State	Area
ALABAMA	K7	ALABAMA	USA	USA
ARIZONA	K2	ARIZONA	USA	USA
ARKANSAS	K4	ARKANSAS	USA	USA
BAHAMAS, COMMONWEALTH OF THE	MY	BAHAMAS	BHS	USA
BERMUDA ISLANDS	TX	BERMUDA	BMU	USA
CALIFORNIA	K2	CALIFORNIA	USA	USA
COLORADO	K2	COLORADO	USA	USA
CONNECTICUT	K6	CONNECTICUT	USA	USA
DELAWARE	K6	DELAWARE	USA	USA
DISTRICT OF COLUMBIA	K6	DISTRICT OF COLUMBIA	USA	USA
FLORIDA	K7	FLORIDA	USA	USA
GEORGIA	K7	GEORGIA	USA	USA
IDAHO	K1	IDAHO	USA	USA
ILLINOIS	K5	ILLINOIS	USA	USA
INDIANA	K5	INDIANA	USA	USA
IOWA	K3	IOWA	USA	USA
KANSAS	K3	KANSAS	USA	USA
KENTUCKY	K5	KENTUCKY	USA	USA
LOUISIANA	K4	LOUISIANA	USA	USA

Database Cards

MAINE	K6	MAINE	USA	USA
MARYLAND	K6	MARYLAND	USA	USA
MASSACHUSETTS	K6	MASSACHUSETTS	USA	USA
MICHIGAN	K5	MICHIGAN	USA	USA
MINNESOTA	K3	MINNESOTA	USA	USA
MISSISSIPPI	K7	MISSISSIPPI	USA	USA
MISSOURI	K3	MISSOURI	USA	USA
MONTANA	K1	MONTANA	USA	USA
NEBRASKA	K3	NEBRASKA	USA	USA
NEVADA	K2	NEVADA	USA	USA
NEW MEXICO	K2	NEW MEXICO	USA	USA
NEW YORK	K6	NEW YORK	USA	USA
NEW HAMPSHIRE	K6	NEW HAMPSHIRE	USA	USA
NEW JERSEY	K6	NEW JERSEY	USA	USA
NORTH CAROLINA	K7	NORTH CAROLINA	USA	USA
NORTH DAKOTA	K3	NORTH DAKOTA	USA	USA
OAKLAND OCEANIC CONTROL AREA	K2	UNITED STATES OF AMERICA	USA	USA
OAKLAND OCEANIC CONTROL AREA	K1	UNITED STATES OF AMERICA	USA	USA
OHIO	K5	OHIO	USA	USA
OKLAHOMA	K4	OKLAHOMA	USA	USA
OREGON	K1	OREGON	USA	USA
PENNSYLVANIA	K6	PENNSYLVANIA	USA	USA
RHODE ISLAND	K6	RHODE ISLAND	USA	USA
SOUTH CAROLINA	K7	SOUTH CAROLINA	USA	USA
SOUTH DAKOTA	K3	SOUTH DAKOTA	USA	USA
TENNESSEE	K7	TENNESSEE	USA	USA
TEXAS	K4	TEXAS	USA	USA
UNITED STATES OF AMERICA	K4	HOUSTON OCEANIC	USA	USA
UNITED STATES OF AMERICA	K6	NEW YORK OCEANIC	USA	USA
UNITED STATES OF AMERICA	K7	MIAMI OCEANIC	USA	USA
UTAH	K2	UTAH	USA	USA
VERMONT	K6	VERMONT	USA	USA
VIRGINIA	K6	VIRGINIA	USA	USA
WASHINGTON	K1	WASHINGTON	USA	USA
WEST VIRGINIA	K6	WEST VIRGINIA	USA	USA
WISCONSIN	K5	WISCONSIN	USA	USA
WYOMING	K1	WYOMING	USA	USA

APPENDIX 3 - HOW DOES GPS WORK?

WHAT IS GPS?

Many of the radio-navigation aids used in aviation were originally developed for military use but have now been made freely available to civil users. The Global Positioning System (GPS) has a similar history. The GPS constellation of satellites is an American military facility operated by the US Department of Defense (DOD). This constellation consists of 21 operational satellites plus three spares held in reserve to replace any of the active ones that might fail. They orbit approximately 10,900 nm above the earth in six planes inclined at a 55 degree angle to the Equator and circle the earth twice daily. The orbits are so arranged that a minimum of four satellites will always be visible from any part of the earth's surface at any time. This allows suitable receivers to make extremely accurate determination of latitude, longitude, altitude, velocity and time from satellite signals received by an aircraft, airborne or on the ground.

HOW DOES IT WORK?

Each satellite carries an extremely accurate atomic clock and continuously transmits precise timing waveforms and data concerning its health status and almanac, orbital information and clock timing corrections. The signals have been designed to be extremely resistant to interference from terrestrial radio transmissions, electronic equipment and weather.

The technique used to establish position using these satellites is one of simple ranging. In other words, position is calculated from measurements of the distances between the observer and a number of satellites. The exact position of each satellite at any given time is known. This information is actually transmitted by each satellite every few minutes. The precise time (in relation to Universal Time) that each satellite starts to transmit its coded signal is also known.

Given this information and the speed of radio waves through space, it is possible to establish the exact distance from each satellite by simple mathematics. For example, if a car leaves point A at exactly 1 o'clock and travels at sixty miles an hour to point B, which it reaches at exactly 2 o'clock, we know the distance between points A and B must be sixty miles.

In order to achieve the required degree of accuracy from this technique it would normally be necessary to have an extremely accurate atomic clock built into each receiver as well as each satellite. This would not be viable as each receiver would then cost tens of thousands of pounds.

How Does GPS Work?

Instead, an ingenious system is used whereby GPS receivers require to be fitted with only reasonably accurate (and thus low-cost) clocks. This involves two important techniques:

1) Code matching or synchronization. Each satellite transmits, for civilian use, a unique 1023 bit code. This code is repeated every millisecond (one thousandth of a second).

In the receiver, circuitry generates an identical code that is then slid back and forth in time until it exactly matches the code being received from the satellite.

When a perfect match is achieved, the time at which the receiver is generating the start bit of the code is recorded. The difference in time (or offset) between the receiver generating the code and the satellite generating the code is therefore measurable because the time at which the satellite should have generated the code is known.

This gives a very accurate way of measuring the time differences between transmission and reception of the signals generated by the satellites, but does not help with the need for an absolute time reference. One must bear in mind that if the clock in the receiver were only 100 milliseconds (one tenth of a second) out with respect to universal time, the calculated distance from the satellite would have an error of 1,860 miles.

This problem is overcome by a second technique:

2) Making use of an extra satellite. In order to obtain a positional fix in three dimensional space, it is necessary to know the exact distance to each of three satellites. The exact distance is however not known because of the presence of an offset or error in the receiver's clock with respect to universal time.

A fix is nevertheless calculated using the three satellites, all be it erroneous. Once this fix is calculated, a second fix is calculated using satellites 2 and 3 in conjunction with a fourth satellite. This is repeated for satellites 3, 4 and 1 then 4, 1 and 2. This gives four calculated points in space.

If the four calculated points do not overlap, a timing error must be present.

A slight correction is then fed into the receiver's clock and the points are calculated again. They move closer to each other.

This process is repeated until all the calculations tie up correctly at the same point. The exact position in three-dimensional space is then known and the offset in the receiver's clock eliminated.

Similarly, a two-dimensional fix can be established from three satellites.

As a result of this technique the receiver does not initially need to know absolute universal time. All that is needed is a reasonably stable clock

for taking relative measurements over the short periods between the signals received from each satellite.

An approximate knowledge of universal time is required, to know which satellite to expect in which part of the sky. This is usually given by the first satellite the receiver acquires after switch on.

The exact universal time is transmitted as part of the almanac and health status data by each satellite. This is then corrected by the receiver for signal transition delay as part of the position fix calculations.

ACCURACY AND RELIABILITY

All GPS satellites transmit two separate pseudo-random codes on two different frequencies.

The most accurate is the P code, which is transmitted at both 1.2276 GHz (1.2276 thousand million cycles per second) and 1.57542 GHz.

The P code is extremely complex and has a repetition rate of one week. This code is restricted to military use only, is capable of supreme accuracy and is supposedly unbreakable.

The signal available to civilian users is transmitted on 1.57542 GHz only and is called the C/A code. C/A stands for Coarse Acquisition.

This code is relatively simple compared to the P code and has a repetition rate of one millisecond.

The present maximum accuracy for receivers using the C/A code is 15 meters.

There is the possibility however of this being intentionally degraded (by feeding random errors into the satellite clocks) to 100 meters for strategic reasons. This is called Selective Availability or S/A and can be implemented at will by the DOD.

Day to day accuracy is monitored by Falcon Air Force Base, Colorado, who receive information from a group of ground stations positioned at Ascension Island, Diego Garcia, Kwagale and Hawaii.

These stations receive the satellite signals and check them for timing accuracy. If any errors are detected, error information is transmitted back to the satellite, which then corrects itself.

Reliability should be good when the full constellation of 24 satellites are in orbit.

Each satellite has three separate clocks on board (one in use and two standby) and in the event of the total failure of a satellite, one of the spares already in orbit can be maneuvered into position within a few hours.

How Does GPS Work?

The only time the DOD can predict there may be a substantial break in coverage for civilian users, is at a time of National Emergency, when the whole system may be reverted to P code (military) operation only, for strategic reasons.

APPENDIX 4 - DIFFERENTIAL FUNCTIONS

Your KMD 150 unit has been designed to enable it to make use of Differential GPS (DGPS) correction.

WHAT IS DGPS?

GPS on its own is, as we have seen in Appendix 3, an extremely accurate system for all general navigation purposes. It is not, however, perfect. The most significant source of error in GPS positional calculations is the deliberate downgrading of accuracy known as Selective Availability (SA) described in Appendix 3. Satellite clocks, although superbly accurate, also have tiny errors that can affect the accuracy of a fix. So also does any slight drift from a satellite's predicted orbit. The signals from satellites have to pass through the earth's atmosphere and, although radio signals travel at the speed of light, this is only a constant through a vacuum. Things like water vapor in the troposphere and charged particles in the ionosphere do slow down satellite signals and cause slight delays that translate into errors in position. And finally it must be admitted that GPS receivers are not perfect either. These can themselves induce further small positional errors, mainly as a result of receiver noise or clock inaccuracy.

DGPS can virtually cancel out all of the errors due to SA, to orbital errors and to satellite clock inaccuracy. It also greatly reduces any error caused by the atmospheric delay to radio signals. What DGPS cannot correct for are only the inaccuracies due to the GPS receiver itself and possible "multi-path" errors which (like "ghosting" on a TV) are due to secondary signals being received after reflection off local obstructions. The net result of all this is that while standard GPS can experience errors of between 15 and 100 meters (depending largely on whether SA is active or not) DGPS is already capable of accuracies down to 1.3 meters horizontally and 2.0 meters vertically.

HOW DOES DGPS WORK?

Any two GPS receivers within a few hundred miles of each other will receive satellite signals that have been affected by virtually the same errors as each other. The signals emanate from the same group of satellites, travel through the same portion of the earth's atmosphere and so will be subjected to the same delays. Thus, all the errors (except those due to multi-pathing and to the receivers themselves) will be common to both. So if one of these receivers is located at a fixed point that has been extremely, precisely surveyed it can be used as a reference. Instead of using the signals to calculate its position, since it already knows its position it can calculate the errors in the incoming signals.

Having established the magnitude of the errors all that is then needed is an associated transmitter broadcasting signals to tell any mobile GPS receivers in the area exactly what these errors are. The mobile GPS's are then able to use this data to correct for the errors in their raw calculations and to come up with the positional accuracies mentioned previously. DGPS even removes the deliberate degrading of accuracy associated with the DOD's Selective Availability. It is essential to process the data from the reference receiver very rapidly and to transmit the correction data to the mobile GPS receivers almost instantaneously since, especially if SA is active, these errors are constantly varying. Transmitters and receivers have to be designed to work at high baud (bits per second) rates to transfer the necessary data before it becomes out of date.

USES OF DGPS

Standard GPS provides very adequate accuracy for most navigational tasks, but the additional precision available through DGPS opens up other possibilities in aviation and in many other spheres of activity. Once the aviation authorities are prepared to approve DGPS-based low-visibility approach and landing systems, these could provide low-cost precision facilities world-wide. The benefits of this could be especially useful at small airports where the expense of an ILS or MLS system could never be justified and in developing countries where few if any navigation aids exist today.

DGPS has also already become an essential tool of the off-shore oil industry, enabling drill bits to be placed with more precision than any other system. Marine navigation, survey work and cartography, emergency services, agriculture and forestry and road transport fleet management are just some of the non-military applications already relying more and more upon the accuracy of DGPS.

APPENDIX 5 - DATABASE INFORMATION

Due to Honeywell's policy of continual development and routine database updates, new database cards will become available every 28 days. As a registered owner of a KMD 150, you will be offered a 1/3/6/12 monthly database card subscription.

DATABASE CYCLE INFORMATION

Keeping the database current in your KMD 150 is your responsibility. Honeywell maintains its databases to be current at all times to the latest Jeppesen 28-day data cycle. It is strongly recommended from a safety viewpoint that you continue to keep your database current. The KMD 150 is not however, an IFR primary means of navigation system. Therefore, its use as an advisory navigation system does not mandate that the database is current.

For GPS database subscriptions contact Navigation Services at the following numbers:

1-800-247-0230 if calling within the United States or Canada

(913) 712-3145 if calling from outside the United States or Canada

(913) 712-3904 FAX

e-mail: nav.database@honeywell.com

Or visit www.gpsdatabase.com

Also, within the United Kingdom contact:

Skyforce Avionics Limited

5 The Old Granary

Boxgrove, Chichester

West Sussex

United Kingdom

PO21 0ES

Phone: +44 1243 783763

Fax: +44 1243 783992

Intentionally left blank

Honeywell International Inc.

One Technology Center

23500 West 105th Street

Olathe, Kansas 66061

Telephone (913) 712-0400

Copyright ©2000-2002, 2004, 2005 Honeywell International Inc.

All rights reserved.

006-18220-0000

Rev 4 Apr/2005 Printed in U.S.A.

Honeywell